

# Elevated Residential Structures



Federal Emergency Management Agency

# Elevated Residential Structures



# Acknowledgments

---

Many people contributed valuable assistance to the preparation of this manual. We wish to acknowledge especially the guidance provided by Melita Rodeck and, later, John Gambel, the Federal Emergency Management Agency's technical representatives in this work. John Gambel's advice was particularly valuable in determining the final content and form of this manual. In addition, this project would not have been possible without the help of Richard W. Krimm, Assistant Associate Director of the Federal Emergency Management Agency's Office of Natural and Technological Hazards, who saw the importance of increasing architects' involvement in flood damage mitigation efforts. Finally, Ray Fox provided a wealth of useful advice in addition to his technical services throughout the course of the project.

## Prepared by

The American Institute of Architects Foundation  
1735 New York Avenue, N.W.  
Washington, D.C. 20006

Charles R. Ince, Jr., President  
Earle W. Kennett, Administrator, Research

Donald E. Geis, Program Director and Project Manager  
Karen N. Smith, Administrative Manager  
Paul K. McClure, Editor

## Technical Consultants

Raymond R. Fox  
Professor of Civil Engineering  
The George Washington University  
Washington, D.C.

Mark Riebau  
Assistant Chief of Floodplain and Shoreland Management  
Wisconsin Bureau of Water Regulation and Zoning  
Madison, Wisconsin

## Cost Consultant

Daniel Mann Johnson & Mendenhall, Architects-Engineers  
Washington, D.C.  
Paul Brott, Vice President  
Ernest Posch, Estimator

The Design Studies section of the manual was developed on the basis of background data and design concepts submitted for the 1976 version of this manual by Zane Yost and Associates, Bridgeport, Connecticut; KEF Corporation, Metairie, Louisiana; Keck and Keck Architects, Chicago; Duval/Johlic Architects-Planners, San Francisco; Louisiana State University, Department of Architecture; Rhode Island School of Design; University of California at Los Angeles, School of Architecture and Urban Planning; and University of Miami, School of Architecture.

## Graphics and Book Design

Assarsson Design Company  
Washington, D.C.  
Allan G. Assarsson, President  
Mark P. Jarvinen, Layout and Graphic Design  
Jeffery Banner, Graphic Design

## Photographs

Raymond R. Fox, Dames & Moore, pp. 64 and 124 and Figures 4.23 and 4.26; Federal Emergency Management Agency, p. 1 and Figure 4.1; U.S. Geological Survey, pp. vi, 122, and 123; U.S. Department of Housing and Urban Development, p. 118 and Figure 2.3; Philip Schmidt, U.S. Department of Housing and Urban Development, Figure 2.7; National Park Service, pp. iv and 112; Spencer Rogers, p. 18; Rosenthal Art Slides, Figures 3.1 and 3.2; AIA Library, Figures 3.3 and 3.4; U.S. Army Corps of Engineers, pp. 3 and 115; Davis and Associates, Figure 4.49; Pittsburgh City Planning Department, p. 4; PARNG Photo, p. 2; and James K. M. Cheng, p. 98.

Most of the photographs and design data in the Recent Design Examples section were supplied by the designers of the buildings shown there. All other photographs were taken by Donald E. Geis of The American Institute of Architects Foundation.

## Disclaimer

The statements contained in this manual are those of The American Institute of Architects Foundation and do not necessarily reflect the views of the U.S. Government in general or the Federal Emergency Management Agency in particular. The U.S. Government, FEMA, and The American Institute of Architects Foundation make no warranty, express or implied, and assume no responsibility for the accuracy or completeness of the information herein.

This manual was prepared under Contract No. EMC-C-0579 with the Federal Emergency Management Agency.

# Table of Contents

---

ACKNOWLEDGMENTS	ii
PREFACE	v
<b>ENVIRONMENTAL AND REGULATORY FACTORS</b>	<b>1</b>
<b>FLOODING AND THE BUILT ENVIRONMENT</b>	<b>1</b>
<i>Riverine Flooding</i> □ <i>Coastal Flooding</i>	
<b>FLOODPLAIN MANAGEMENT</b>	<b>4</b>
<i>National Flood Insurance Program</i> □ <i>Base Flood Elevations</i> □ <i>A and V Zones</i>	
<b>SITE ANALYSIS AND DESIGN</b>	<b>8</b>
<b>SITE SELECTION AND ANALYSIS</b>	<b>9</b>
<b>SITE DESIGN</b>	<b>13</b>
<i>Site Flooding Characteristics</i> □ <i>Access and Egress</i> □ <i>Vegetation</i> □ <i>Flood Water Drainage and Storage</i> □ <i>Dune Protection</i>	
<b>ARCHITECTURAL DESIGN EXAMPLES</b>	<b>18</b>
<b>DESIGN STUDIES</b>	<b>22</b>
<i>Bridgeport</i> □ <i>Charleston and Newport</i> □ <i>San Francisco</i> □ <i>Chicago</i>	
<b>AESTHETIC CONSIDERATIONS</b>	<b>35</b>
<b>RECENT DESIGN EXAMPLES</b>	<b>45</b>
<i>Logan House</i> □ <i>Summerwood on the Sound</i> □ <i>Breakers Condominium</i> □ <i>Campus-by-the-Sea Facility</i> □ <i>Starboard Village</i> □ <i>Gull Point Condominiums</i>	
<b>DESIGN AND CONSTRUCTION GUIDELINES</b>	<b>64</b>
<b>FOUNDATIONS</b>	<b>65</b>
<i>Fill</i> □ <i>Elevated Foundations</i> □ <i>Shear Walls</i> □ <i>Posts</i> □ <i>Piles</i> □ <i>Piers</i> □ <i>Bracing</i>	
<b>FRAMING CONSTRUCTION AND CONNECTIONS</b>	<b>80</b>
<i>Framing Methods</i> □ <i>Floor Beams</i> □ <i>Cantilevers</i> □ <i>Concrete Flooring Systems</i> □ <i>Floor Joists</i> □ <i>Subflooring</i> □ <i>Wall Sheathing and Bracing</i> □ <i>Roof Connections</i>	
<b>RELATED DESIGN CONSIDERATIONS</b>	<b>92</b>
<i>Glass Protection</i> □ <i>Utilities and Mechanical Equipment</i> □ <i>Building Materials</i> □ <i>Insulation</i> □ <i>Breakaway Walls</i> □ <i>Retrofitting Existing Structures</i>	
<b>COST ANALYSIS</b>	<b>98</b>
<b>RESOURCE MATERIALS</b>	<b>112</b>
<b>GLOSSARY</b>	<b>113</b>
<b>SOURCES OF DESIGN INFORMATION</b>	<b>116</b>
<b>FEMA REGIONAL OFFICES</b>	<b>118</b>
<b>STATE COORDINATING OFFICES FOR THE NFIP</b>	<b>120</b>
<b>PERFORMANCE CRITERIA</b>	<b>125</b>
<b>REFERENCES</b>	<b>136</b>



# Preface

---

Whenever possible, residential structures should not be located in flood-prone areas. Flooding in these areas is virtually assured at some point in the future, bringing with it the potential for property damage—no matter how well a structure is designed—as well as danger to building occupants. However, it is not always possible to avoid flood-prone areas. This manual is for designers, developers, builders, and others who wish to build elevated residential structures in flood-prone areas prudently.

The readers of this manual are assumed to have knowledge of conventional residential construction practice; the manual is limited to the special design issues confronted in elevated construction.

This is a revision of a manual of the same title published in 1976 by the Federal Insurance Administration. This revision reflects changes since 1976 in floodplain management techniques and regulations, improvements in construction materials and practice, increases in construction costs, and additions to the relevant literature. This revision also contains increased information on elevating structures in coastal areas, although all the techniques described here apply to both coastal and riverine areas unless otherwise stated.

A second document, published by the Federal Emergency Management Agency (FEMA), *Design Guidelines for Flood Damage Reduction*, supplements this manual's discussion of elevated residential structures with information on the full range of other floodplain management strategies.

A third document, *Design and Construction Manual for Residential Buildings in Coastal High Hazard Areas*, is published jointly by FEMA and the U.S. Department of Housing and Urban Development. It provides structural engineering guidelines and other information on designing structures in coastal areas subject to severe wind and velocity wave forces. Structures in such areas should not be designed without consulting it.

# ENVIRONMENTAL AND REGULATORY FACTORS

---

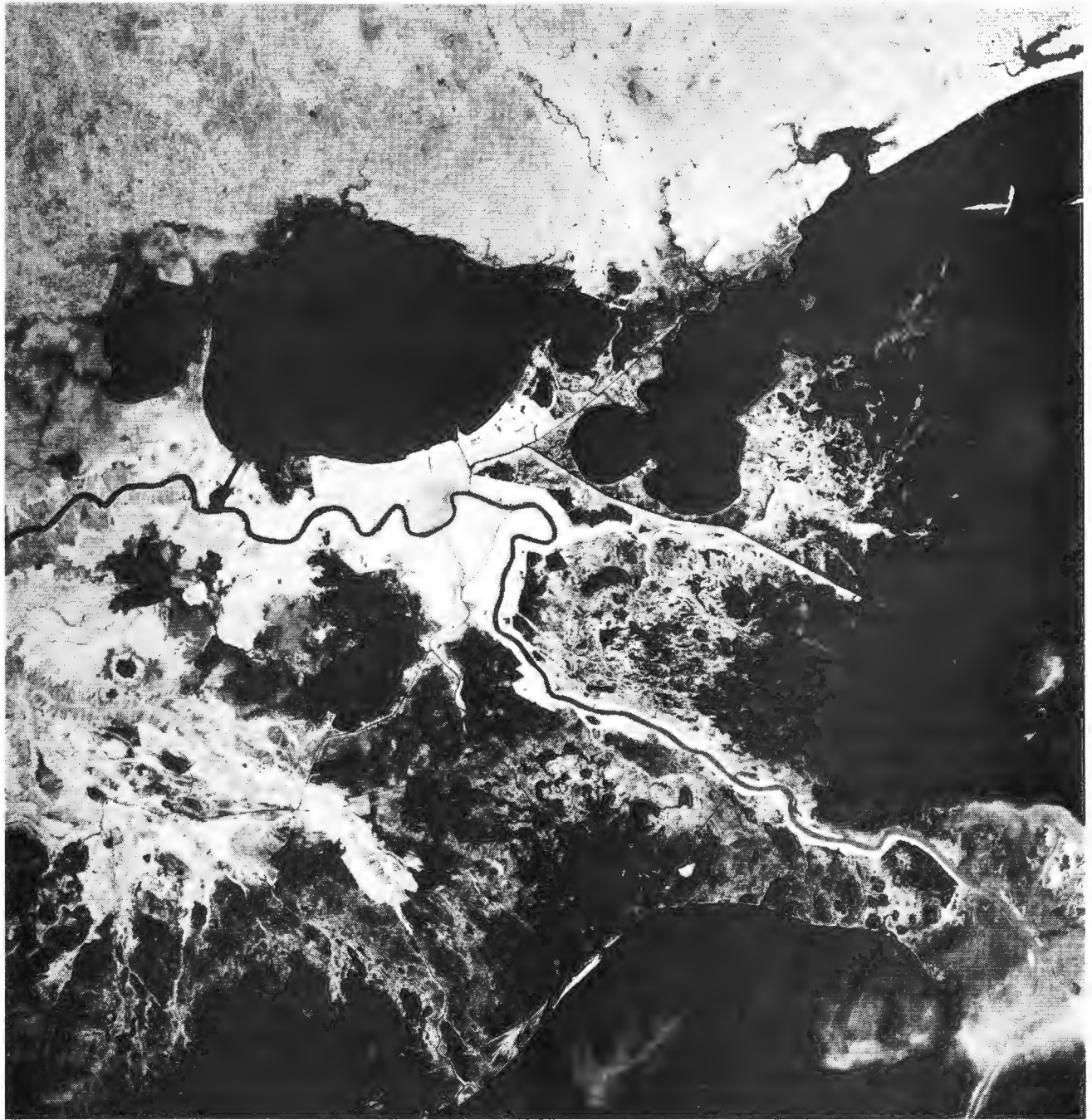

# Flooding and the Built Environment

---

Rivers and seacoasts have always been focal points for development. Access to water has provided drinking supplies and sanitation, an important source of energy, and a valuable part of the transportation system. Recreational opportunities and aesthetic enjoyment further stimulate waterside development.

This development pattern, however, leads to a conflict between the natural and built environments. The need for direct access to water places human settlements in low-lying areas that are subject to periodic flooding by rivers and the sea. In the United States, more than six million dwellings and a large number of nonresidential buildings are currently located in the nation's 160 million acres of floodplains. Flooding of these floodplains is responsible for more damage to the built environment than any other type of natural disaster. The total flood damage in 1978, for example, was an estimated \$3.8 billion. The following year, Hurricane Frederic alone caused \$1.8 billion in damages.

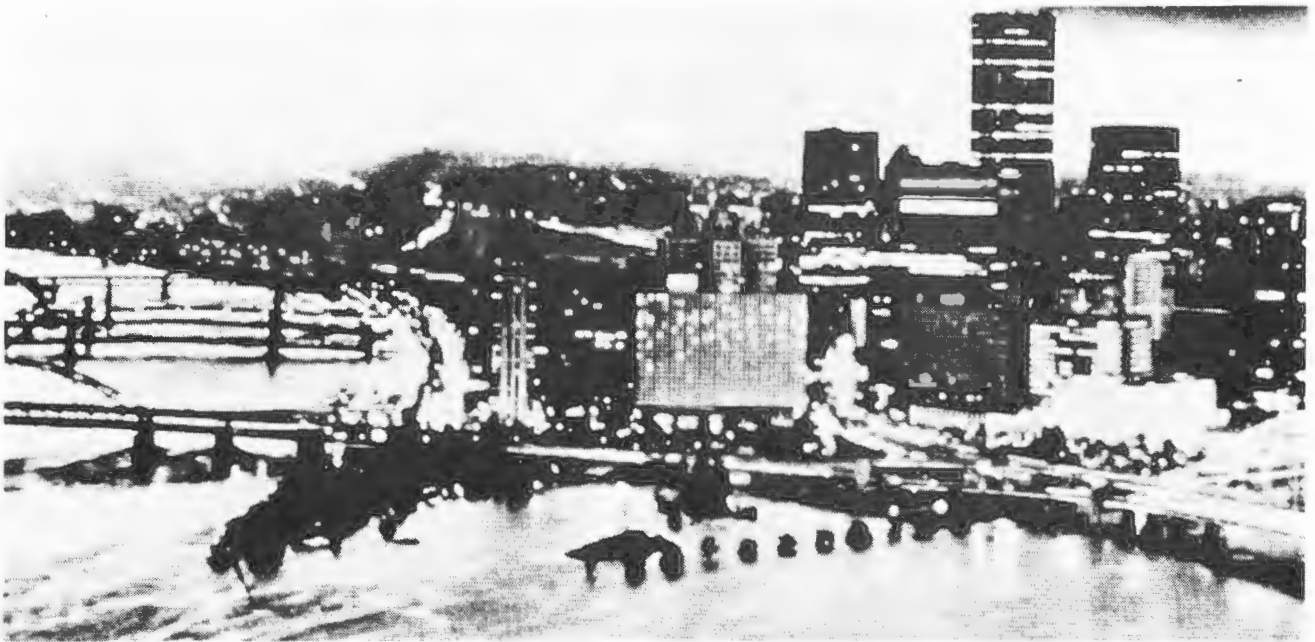





## RIVERINE FLOODING

Floods are part of the natural hydrologic process. Riverine flooding is associated with a river's watershed, which is the natural drainage basin that conveys water runoff from rain and melting snow. Water that is not absorbed by soil or vegetation seeks surface drainage lines, following local topography and creating rivers and other streams. Flooding results when flow of runoff is greater than the carrying capacity of watershed streams.

Riverine flooding usually involves a slow buildup of water and a gradual inundation of surrounding land. However, flash flooding, a quick and intense overflow with high water velocities, can result from a combination of steep slopes, a short drainage basin, and a high proportion of surfaces impervious to water and unable to absorb runoff.

In addition to the direct threat to buildings, development in riverine floodplains alters natural topography, modifying drainage patterns and usually increasing storm water runoff. Development also displaces much of the natural vegetation that formerly absorbed water and decreases the permeability of the soil by covering it with buildings or with nonporous surfaces for roads, sidewalks, and parking. The effect of these changes is to increase the severity of flooding throughout the riverine environment.

## COASTAL FLOODING

Coastal flooding is generally due to severe ocean-based storm systems. Hurricanes, tropical storms, and extratropical storms such as "northeasters" are the principal causes, with flooding occurring when storm tides are higher than the normal high tide, and are accompanied by water moving at relatively high velocity and velocity wave action. The maximum intensity of a storm tide occurs at high tide, so storms that persist through several tides are the most severe.

---

The velocity and range of coastal floods vary in part with the severity of the storm that induces them. The damaging effects of coastal flooding are caused by a combination of the higher water levels of the storm tide and the rain, winds, waves, erosion, and battering by debris.

The extent and nature of coastal flooding is also related to physiographic features of the terrain and the characteristics of the adjoining body of water. Pacific coastal areas are vulnerable principally to earthquakes, tsunamis (seismically induced tidal waves) and other natural forces that can trigger excessive erosion, mud slides, and flash flooding. Great Lakes coastal areas are subject to erosion and severe winter storms. The Atlantic and Gulf Coasts are consistently exposed to the forces of hurricanes, lesser tropical storms, and northeasters.

Coastal flooding is most frequent on the Atlantic and Gulf Coasts, which are made up of a succession of barrier islands, beaches, and dunes. These physiographic elements are maintained in dynamic balance as sand is moved by wind, waves, and ocean currents. This self-replenishing beach-dune system takes the brunt of the force of storm surges and helps buffer inland areas.

In coastal areas the removal of beach sand and the leveling of dunes, along with the construction of seawalls, jetties and piers, are common practice. These can help destroy the shoreline's natural protection system, exacerbating the impact of storm surges and high winds.



# Floodplain Management

---

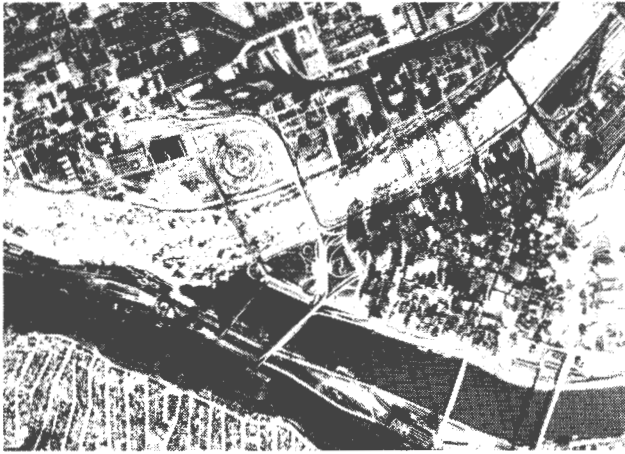

There have long been attempts to moderate the impact of riverine flooding, with major federal efforts in the United States since 1936. Until recently, these efforts have been concentrated on flood control measures devised to reduce or eliminate flooding itself—chiefly dams, levees and similar structural works. Despite a number of positive results, these measures have not succeeded in reducing flood damage significantly.

Since the mid-1960s, therefore, federal policies have reflected a recognition that structural works need to be complemented by nonstructural measures. Rather than trying solely to prevent floods, current floodplain management programs address the need to reduce the losses incurred when inevitable flooding does happen.

Elevating residential structures above the reach of flood waters, the subject of this manual, is only one of several floodplain management techniques currently used to reduce flood damage. For example, construction is prohibited in critical floodplain areas (termed floodways) unless it has been determined that construction will not increase flood levels elsewhere. Where buildings are already located in these critical areas, they can either be relocated out of the flood area, elevated, or floodproofed to reduce the damage they will suffer in a flood. Buildings that are badly damaged by flooding can be razed or floodproofed rather than being restored to their original, vulnerable condition. Vacant land in flood-prone areas can be purchased by the local community and reserved for recreation, farming, or other safe uses.

These and other floodplain management techniques (discussed in *Design Guidelines for Flood Damage Reduction*, cited in the Preface) can be used in a coordinated way to respond to each community's various needs, resources, and flood hazards. Elevated residential structures, if used at sites appropriate for them, can be useful components of effective floodplain management.

---

## NATIONAL FLOOD INSURANCE PROGRAM

The National Flood Insurance Program (NFIP) is the federal government's principal administrative mechanism for reducing flood damage. Established by Congress in 1968, the NFIP is administered by the Federal Emergency Management Agency (FEMA). The NFIP insures buildings and their contents in flood-prone areas, where conventional insurance had, prior to the NFIP, been generally unavailable.

The NFIP provides this insurance only in communities that agree to implement comprehensive land-use planning and management to reduce the likelihood of flood damage in their jurisdictions. Community response to this incentive generally involves the adoption of zoning, building code, and development regulations that place various requirements and restrictions on new construction and on substantial improvements to existing construction.

*Note that some local governments have adopted codes and zoning ordinances that are considerably more restrictive than the minimums required by FEMA. The result is that familiarity with design requirements in one community cannot be relied on elsewhere.*

The rate structure of the NFIP's insurance premiums reinforces the intent of these regulations by charging higher insurance rates for buildings subject to greater hazard. These insurance rates are set primarily on the basis of designated hazard zones and the elevation of the building or structure in relation to the level of flooding likely to occur in each zone. This differential rate structure provides a significant financial incentive to locate buildings in less hazardous zones or to increase buildings' flood safety by elevating them higher than the NFIP's minimum elevations.



It is thus vital to be aware of the NFIP rate structure, as well as local regulations, when siting and designing new development or substantial improvements to existing construction. This information can be obtained from local insurance agents, public officials, and regional FEMA offices.

### BASE FLOOD ELEVATIONS (BFE's), A ZONES, AND V ZONES

The NFIP and related local and state regulations define likely flood levels on the basis of the "100-year" flood, which is the flood that has a one percent chance of being equalled or exceeded during any given year. Over a 30-year period, there is at least a 26 percent chance that this "base" flood will occur.

The base flood elevations (BFE's), or likely flooding levels, at different sites in a community during the 100-year flood are determined on the basis of historic records, climatic patterns, and hydrologic and hydraulic data. A community's BFE's are mapped on flood insurance rate maps (FIRM's), which are provided by FEMA for use by local floodplain managers and FEMA officials (see Figure 1.1).

FIRM's generally show flood-prone areas as either A Zones or V Zones. Riverine flood-prone areas and coastal flood-prone areas subject to storm surges with velocity waves of less than three feet during the 100-year flood are generally classed as A Zones. FEMA's design standards (see Figures 1.2 and 1.3) for A Zones call for the top of a building's lowest floor (including basements) to be elevated to or above the BFE. "Coastal high hazard areas" are shown on FIRM's as V Zones. The V Zone is the portion of the floodplain subject to storm surges with velocity waves of three feet or more during the 100-year flood. FEMA standards for V Zones require the lowest portion of the structural members supporting the lowest floor to be elevated on pilings or other columns to or above the BFE. In addition, the space below the lowest floor in a V Zone must not be used for human

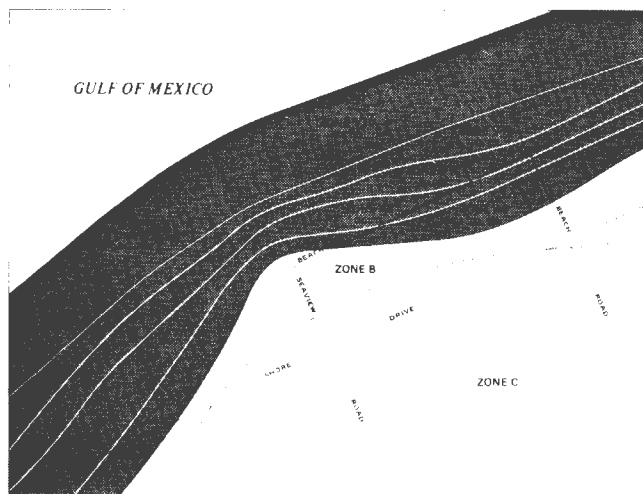

Figure 1.1. Flood Insurance Rate Map

### ON POST-TYPE FOUNDATION

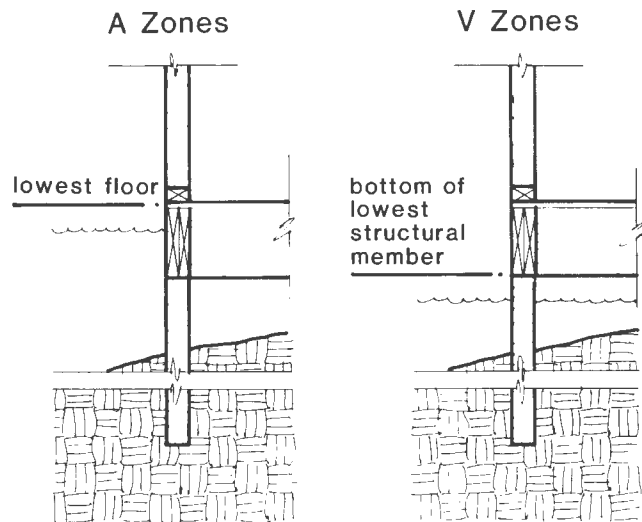

Figure 1.2. Elevation Requirements for Post-Type Foundations

habitation and must be free of obstructions.

NFIP requirements for A and V Zones as of January 1984 are summarized in Figure 1.4.

Note that FIRM's are based on a variety of assumptions about expected flood severity, development patterns, etc. The actual level of flooding from a 100-year flood may be significantly greater. In addition, the "500-year" flood level, which would be significantly greater than the 100-year flood's, could conceivably occur once or even more often during a building's lifetime. These uncertainties are further reasons for locating buildings in less hazardous zones or elevating them higher than the NFIP's minimum elevations.

## ON SLAB FOUNDATION A Zones

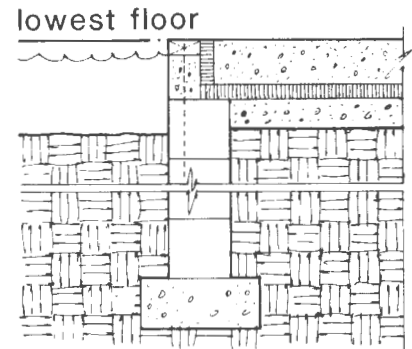

Figure 1.3. Elevation Requirements for Slab Foundations

### BOTH A AND V ZONES (Numbered and Unnumbered)

- All structural components must be adequately connected and anchored to prevent flotation, collapse, or permanent lateral movement of the building during floods.
- Building materials and utility equipment must be resistant to flood damage. All machinery and equipment servicing the building must be elevated to or above the Base Flood Elevation (BFE), including furnaces, heat pumps, hot water heaters, air-conditioners, washers, dryers, refrigerators and similar appliances, elevator lift machinery, and electrical junction and circuit breaker boxes.
- Any space designed for human habitation must be elevated to or above the BFE, including bedroom; bathroom; kitchen; dining, living, family, and recreation room; and office, professional studio, and commercial occupancy.
- Uses permitted in spaces below the BFE are vehicular parking, limited storage, and building access (stairs, stairwells, and elevator shafts only, subject to design requirements described below for walls).

### A ZONES (A1-A30)

- Buildings must be elevated such that the lowest floor (including basement) is elevated to or above the BFE on fill, posts, piers, columns, or extended walls.
- Where fully enclosed space exists below the BFE, walls must be designed to minimize buildup of flood loads by allowing water to automatically enter, flow through (in higher velocity flooding), and drain from the enclosed area. For low velocity conditions, vents, louvers, or valves can be used to equalize flood levels inside and outside enclosed spaces. For high velocity conditions, breakaway walls (see below) or permanent openings should be used.

### V ZONES (V1-V30)

- Buildings must be elevated on pilings or columns such that the bottom of the structural member *supporting* the lowest floor is elevated to or above the BFE.
- Buildings must be certified by a registered professional architect or engineer to be securely fastened to adequately anchored pilings or columns to withstand velocity flow and wave wash.
- Space below the lowest floor must be free of obstruction or enclosed with breakaway walls (i.e., walls designed and constructed to collapse under velocity flow conditions without jeopardizing the building's structural support).
- Fill may not be used for structural support.
- No construction is allowed seaward of the mean high tide line.

Figure 1.4. Key Floodplain Requirements of the National Flood Insurance Program as of January 1984.

# SITE ANALYSIS AND DESIGN

---



# Site Selection and Analysis

---

## SITE SELECTION

Whenever possible, site selection should avoid flood-prone areas. If this is not possible it should be recognized that the risk and severity of flooding generally decreases with the distance from the river channel or from coastal waters. However, this is not always the case, so it is important to check the level of expected floods in relation to the proposed site. If the base flood elevation (BFE) has not been determined, it would be wise to consult local flood history data before making a final site selection.



The regulations of the National Flood Insurance Program (NFIP) specifically prohibit building or landfill in a floodway, if such has been designated, if the results would obstruct the flow of flood waters and thereby increase flood heights. Similarly, building in a coastal high hazard area is also not permitted unless the structure is landward of the mean high tide level.

Development should be diverted away from identified mudslide or erosion-prone areas. Only where site and soil investigation and proposed construction standards assure complete safety for future residents should such sites be considered.

Overall, customary site selection criteria should be used to evaluate the suitability of a site. Drainage, height of the water table, soil and rock formations, topography, water supply, and sewage disposal capability should be considered along with economic and planning criteria such as cost, access, and compatible land use.

## SITE ANALYSIS

The site elements of primary importance for analyzing an elevated residential project are flooding, soil, and wind characteristics.



---

## Flooding Characteristics

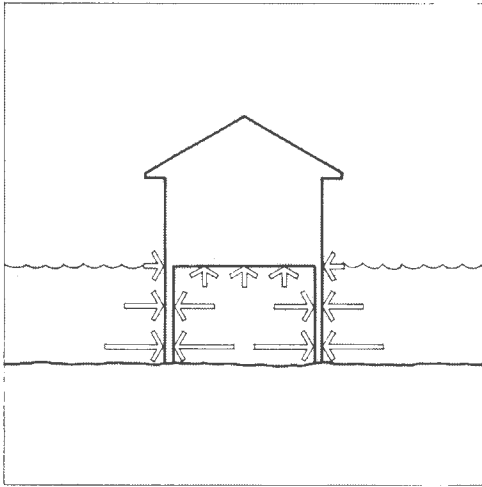

Figure 2.1. Hydrostatic Forces

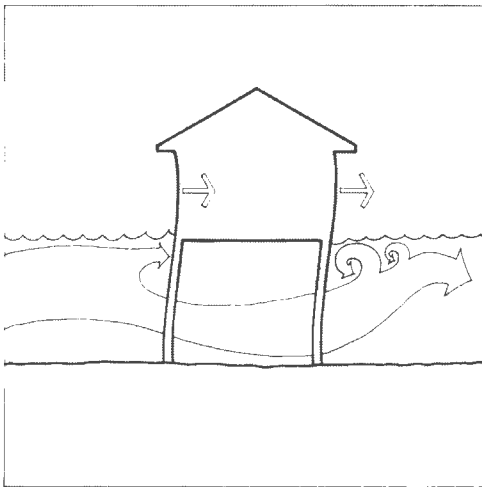

Figure 2.2. Hydrodynamic Forces

Floodwaters impose *hydrostatic* forces and *hydrodynamic* forces. Hydrostatic forces result from the static mass of water at any point of flood water contact with a structure. They are equal in all directions and always act perpendicular to the surface on which they are applied. Hydrostatic loads can act vertically on structural members such as floors and decks, and can act laterally on upright structural members such as walls, piers, and foundations (see Figure 2.1).

Hydrodynamic forces result from the flow of flood water around a structure, including a drag effect along the sides of the structure and eddies or negative pressures on the structure's downstream side (Figure 2.2). These are more common in flash floods, coastal floods, and when flood water is wind-driven.

A number of hydrologic factors must be evaluated in the design of an elevated structure:

- *Depth* of expected flooding and, in coastal areas, height of wave crests, which will determine the required elevation of a building and the hydrostatic forces to be expected.
- *Frequency* of flooding, which is the amount of time between occurrences of damaging floods. This will have an important influence on site selection.
- *Duration* of flooding, which affects the length of time a building may be inaccessible, as well as the saturation of soils and building materials.
- *Velocity* of flood waters and waves, which influences both horizontal hydrodynamic loads on building elements exposed to the water and debris impact loads from waterborne objects.

- 
- *Rate of rise*, which indicates how rapidly water depth increases during flooding. This determines warning time before a flood, which will influence the need for access and egress routes elevated above floodwaters and whether valuable possessions can be kept underneath the structure and moved only when flooding is imminent. Flash flood areas often receive little or no warning of flooding.

Another hydrologic factor is ice, which in northern climates can cause serious damage to structures if flooding should occur during the spring before the ice melts. In some cases winddriven ice or ice jams have completely demolished bridges, homes, and businesses, snapping large trees and pushing buildings completely off their foundations. Floating debris can be equally dangerous in this regard. There is little that can be done to avoid these phenomena short of avoiding sites where they are especially likely to occur.

Hydrologic data concerning a site, including both technical studies and historical records, can often be provided by the local or state government and federal agencies such as the Federal Emergency Management Agency, the U.S. Army Corps of Engineers, and the U.S. Geological Survey. If needed information is not available from these sources, engineers familiar with hydrologic and hydraulic techniques can analyze the flooding potential.

### Soil Characteristics

The characteristics of the soil in a flood area—soil bearing capacity, for example—can be important in determining an appropriate design. Highly erodible soil would not be desirable for use as fill in elevating a structure in a high velocity area unless the fill is properly protected. When erosion removes soils supporting building foundations, the foundations can fail (see Figure 2.3).



Figure 2.3. Erosion Caused This Foundation to Collapse.

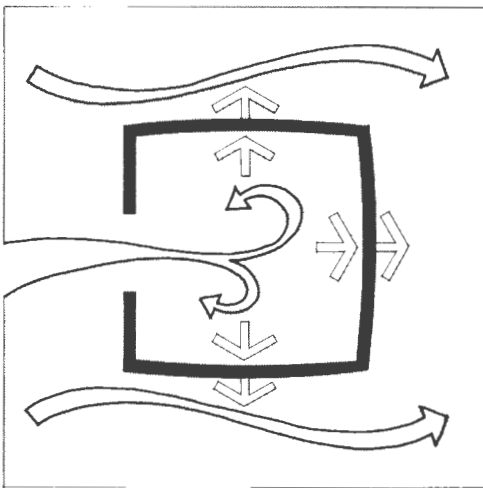
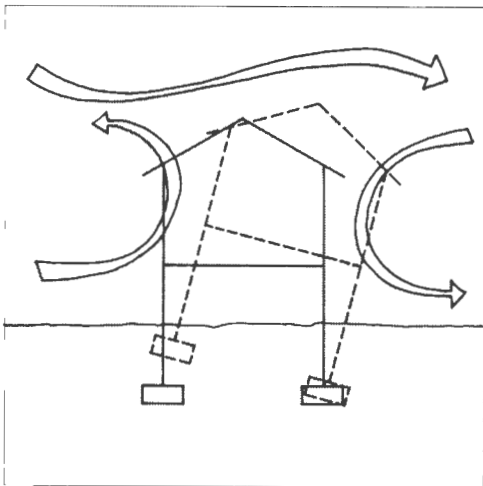
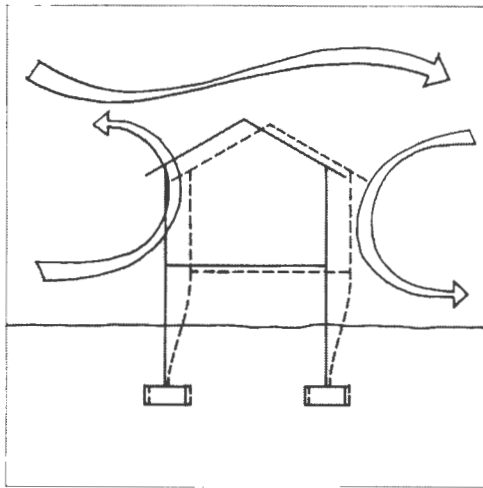

Soil data can be obtained from soil survey reports published by the Soil Conservation Service of the U.S. Department of Agriculture. It may be desirable to consult a qualified soils engineer familiar with the soils at the site.

Large-scale topographic maps of ground elevations can be used to determine natural drainage patterns, mudslide- and erosion-prone areas, and the feasibility of using fill. Local or state agencies or the U.S. Geological Survey can often supply this information. Detailed topographic maps (2-foot contour intervals or less) must usually be developed as part of the site-specific investigation and are necessary for developing grading and landscaping plans.

### Winds

Buildings elevated off the ground can be more vulnerable than other buildings to wind (see Figure 2.4). Data on expected winds appear in building codes and Standard A58.1 of the American National Standards Institute. *Design and Construction Manual for Residential Buildings in Coastal High Hazard Areas*, cited in the Preface, discusses designing for wind in coastal areas.

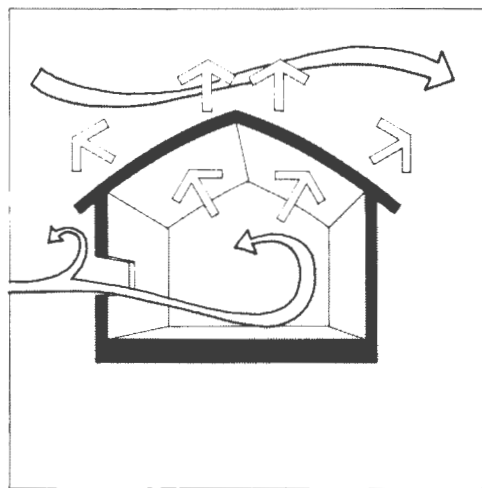

Figure 2.4. Wind Forces

# Site Design

---

Site design for elevated structures should follow standard planning criteria applicable to any site work. Typical factors to consider include slopes, natural grades, drainage, vegetation, orientation, zoning, and location of surrounding buildings, as well as expected direction of flood flow.

## SITE FLOODING CHARACTERISTICS

Buildings should be positioned in the area of the site that will experience the lowest flood levels and velocities. In coastal areas, this means as far back from the beach as possible and, if feasible, behind dunes. Buildings should be oriented to present their smallest cross-sections to the flow of floodwater. This reduces the surface area on which flood and storm forces can act.

When multiple buildings are to be placed on the same site, the objective of site design is the same as for an individual building. One approach is to disperse buildings throughout the site, applying the criteria discussed above to each building. An alternative to such dispersal, when local zoning ordinances allow (e.g., a planned unit development ordinance), is to group buildings in clusters on the safest parts of the site, leaving the more vulnerable areas open. This approach not only reduces flood damage but can also allow greater flexibility in protecting the natural features on the site (see Figure 2.5).

Adjacent buildings, bulkheads, or other structures should also be considered in site layout, both for their potential to screen and divert flood waters and water-borne debris and for their potential to become floating debris themselves. Bulkheads also tend to divert flood waters around their ends, adversely affecting adjacent sites.

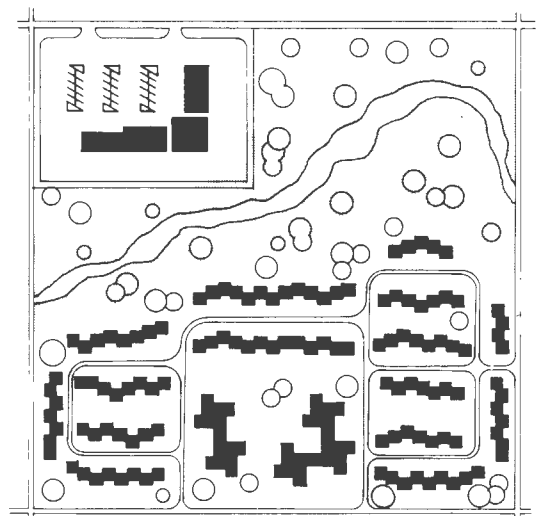

Figure 2.5. Planned Unit Development Ordinances Allow Greater Flexibility in Site Design

## ACCESS AND EGRESS

Access to and egress from a building can be facilitated by locating parking and driveways—as well as the building—in the area of a site least likely to be flooded. Access and egress are important during flooding to ensure that building occupants can evacuate and that police and fire protection and other critical services can continue to be provided.

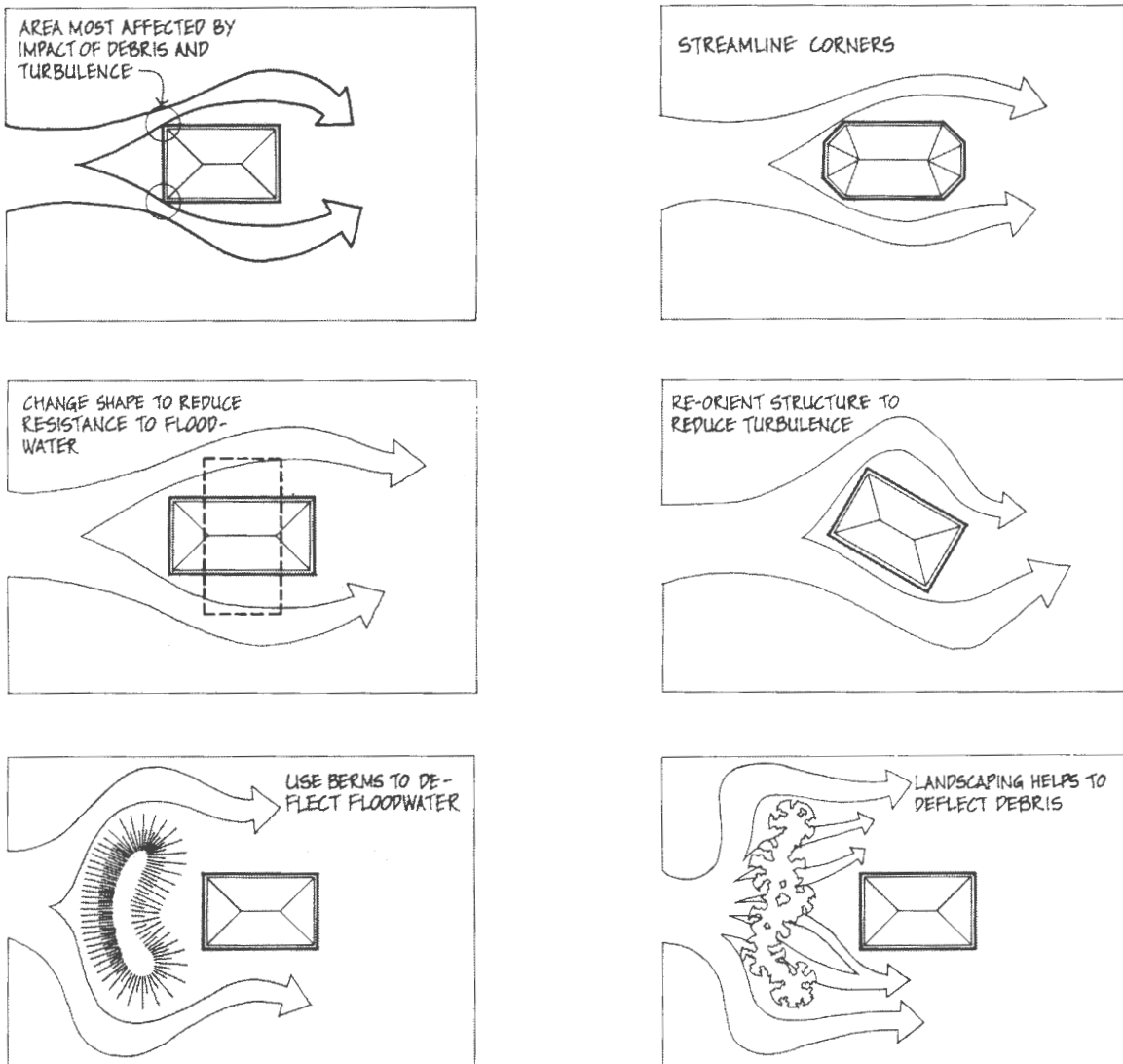

Figure 2.6. Site Design to Reduce Flood Hazards

---

In new developments, roads should be located to approach buildings from the direction away from the floodplain, so that access roads will be less likely to be blocked by flood waters and debris (Figure 2.7). To reduce potential erosion, siltation, and runoff problems, roads should not disrupt drainage patterns, and road crossings should have adequate bridge openings and culverts to permit the unimpeded flow of water. If roads are to be raised, the slope of embankments should be minimized and open faces stabilized with ground cover or terracing.

## VEGETATION

Vegetation aids in slowing the rate of storm water runoff by holding water, thus allowing it to filter into the ground or evaporate gradually. In addition, vegetation helps prevent erosion and sedimentation from flooding. Natural vegetation should be retained wherever practical, and new plantings should be introduced in locations that will be most affected by runoff.

Crushed stone can be used to control erosion under low-lying elevated structures and other locations where vegetation is difficult to maintain.

Larger bushes and trees can be sited to deflect floating debris away from elevated foundations. Landscaping can also be used to screen elevated foundations from view. Trees, plantings, fencing, etc., can all provide this dual function of utility and aesthetics.

## FLOOD WATER DRAINAGE AND STORAGE

Good site drainage in riverine areas allows flood waters to recede from a site without eroding it or leaving standing water that causes damage to structural elements or health hazards from stagnant water.

Water enters a riverine site either from precipitation or as surface runoff from upstream portions of the watershed. What happens to this water can be a major determinant of the degree of flooding and



Figure 2.7. Improperly Sited Streets Can Block Emergency Egress and Access

---

the amount of flood damage. Site development that increases the volume of storm water runoff can increase flooding levels. Ideally, runoff rates after development should not exceed the rates before development.

Site design should work to protect the individual site as well as to minimize increased flood levels elsewhere. A number of key factors such as the amount of nonporous surface and the amount of on-site surface water storage can in part determine the ability of a site to absorb water. Land-use regulations in some communities require developers to defray part of the cost of developing regional water retention sites to offset the effects of development.

On the site, open channels can be used both to divert water away from erodible areas, such as short steep slopes, and to collect and transport water runoff to larger drainage courses. Channels with grass cover are appropriate where the channel gradient and consequent water velocity are low; they then serve as percolation trenches by allowing gradual infiltration while water is being transported. Where vegetation cannot be established, concrete and asphalt paving or riprap can be used as channel linings. However, such linings can increase the velocity of runoff, and consideration should be given to velocity checks to control the rate of flow.

On some sites it may be possible to use fill material—from either on-site or off-site—to improve drainage and control runoff. Special consideration should be given to soil conditions and slope stability, as well as flood water velocities and duration, to avoid erosion during flooding. When restructuring topography, exposed cut and fill slopes, as well as borrow and stockpile areas, should be protected. Runoff should be diverted from the face of slopes, and slopes should be stabilized with ground cover or retaining walls.

---

## DUNE PROTECTION

Dunes provide a natural shoreline defense against storm surges and waves. Most coastal communities require that construction be behind the primary dune and that dunes not be cut or breached by site features such as walkways or beach access roads. Cross-over walkways should be provided (see Figure 2.8).

Existing dunes should be maintained through vegetation and sand fencing, which limit wind losses and promote further dune growth. If no dunes exist and the beach is sufficiently wide, successive tiers of sand fencing can induce dune formation; some communities require this before a residence can be built.

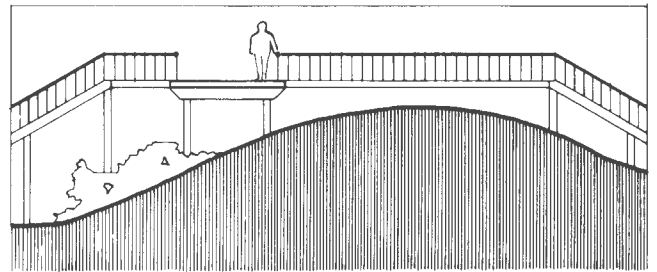
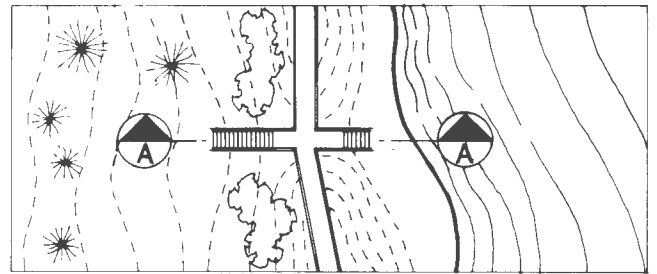

Figure 2.8. Dune Access



# ARCHITECTURAL DESIGN EXAMPLES

---



Many of the twentieth century's most important buildings have been elevated residential structures. The rise of modern architecture, inspired by the raised houses of Le Corbusier in the 1920s, was made possible by structural innovations. The Villa Savoie at Poissy (1929), for example, is lifted above the ground on pilotis, freeing the lower level for parking and affording a spatial continuity with the landscape (Figures 3.1 and 3.2). In his *Towards A New Architecture* Le Corbusier was exultant about the possibilities of elevated design:

The house on columns! The house used to be sunk in the ground: dark and often humid rooms. Reinforced concrete offers us the columns. The house is in the air, above the ground; the garden passes under the house.



Figure 3.1

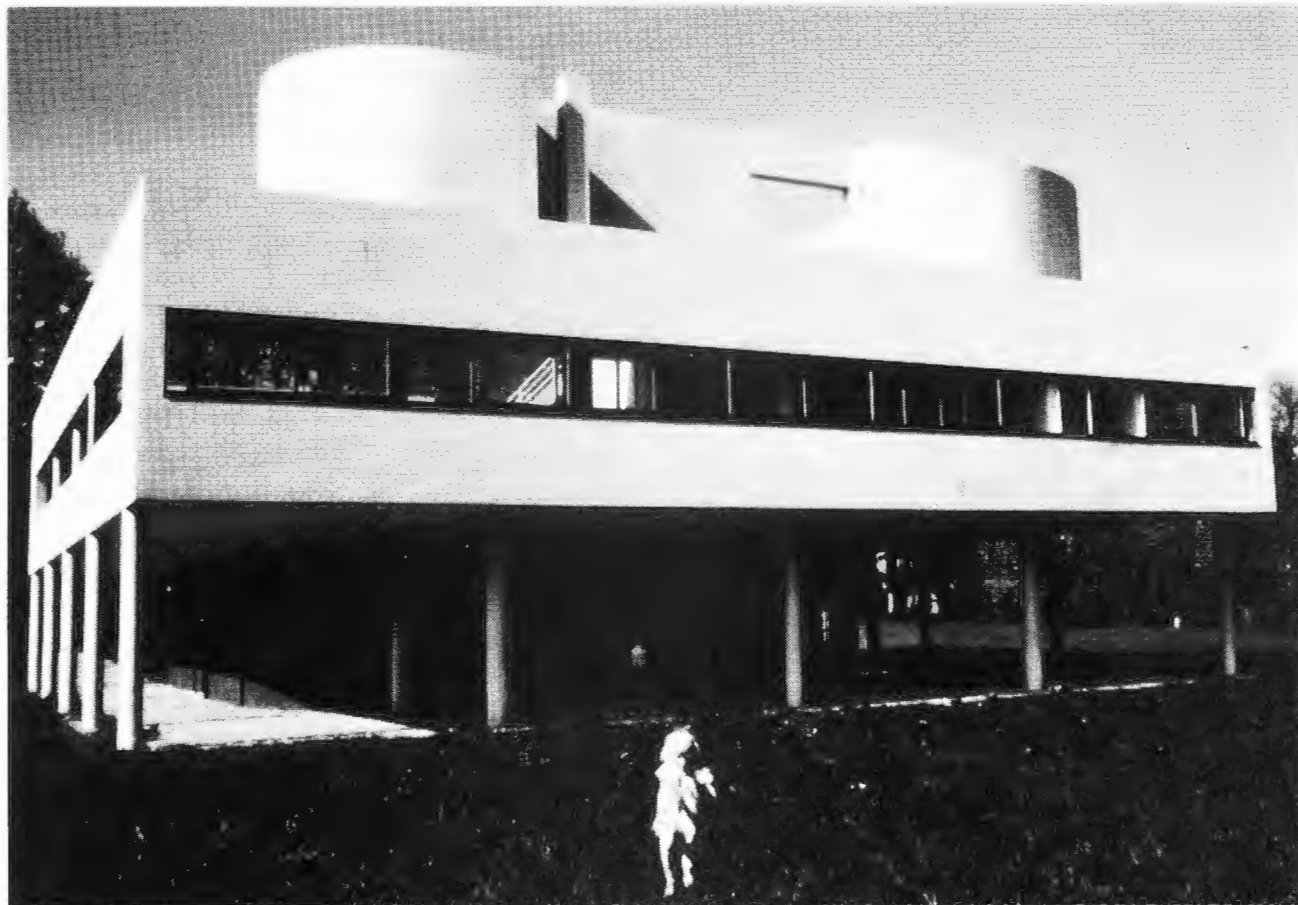

Figure 3.2

---

Since the Villa Savoye was centered on a dome-like rise in a large pasture, Corbusier did not need to concern himself with the problem of flooding. Other masters of modern architecture, however, have used the principles of elevated residential design to create aesthetically satisfying and functionally sound responses to hazardous flood conditions.

Mies van der Rohe's Farnsworth House (1950), considered one of the great icons of modern architecture, owes at least some of its appearance to its flood-prone site (Figures 3.3 and 3.4). Built along the Fox River in rural Illinois, the house was designed to accommodate a body of water that overflows its banks each spring. Mies' solution to the problem was to raise the plane of the first floor above the flood level, creating his first clear-span building. The resulting structure seems to float above its site.

Good design and good flood protection must continue to be treated together. Good design entails effective use of the site and careful consideration of the needs of the surrounding neighborhood and community. The best houses provide a clear transition from ground to dwelling, integrating the foundation with the rest of the structure. Creative landscaping with trees, shrubs, and fences can enhance the appearance of elevated structures by softening the effect of potentially harsh or barren

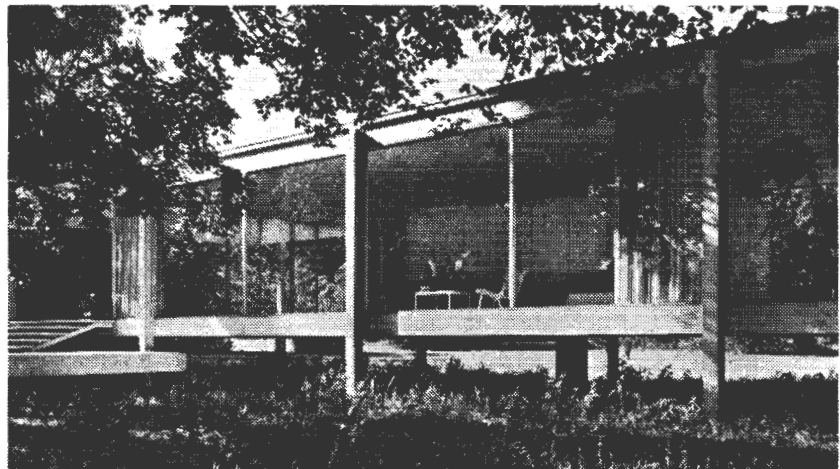

Figure 3.3

---

exposures. Inventive landscaping also helps to control erosion and protect the dwelling from the impact of debris and high velocity flooding. Effective use of terracing and level changes can help achieve continuity with the surrounding areas and, equally important, provide a sense of variety by indicating the different functions that occur simultaneously on a single site.

Such site considerations are but one part of a total elevated design scheme. The following examples are concerned with some of the many other important factors involved in floodproof design.

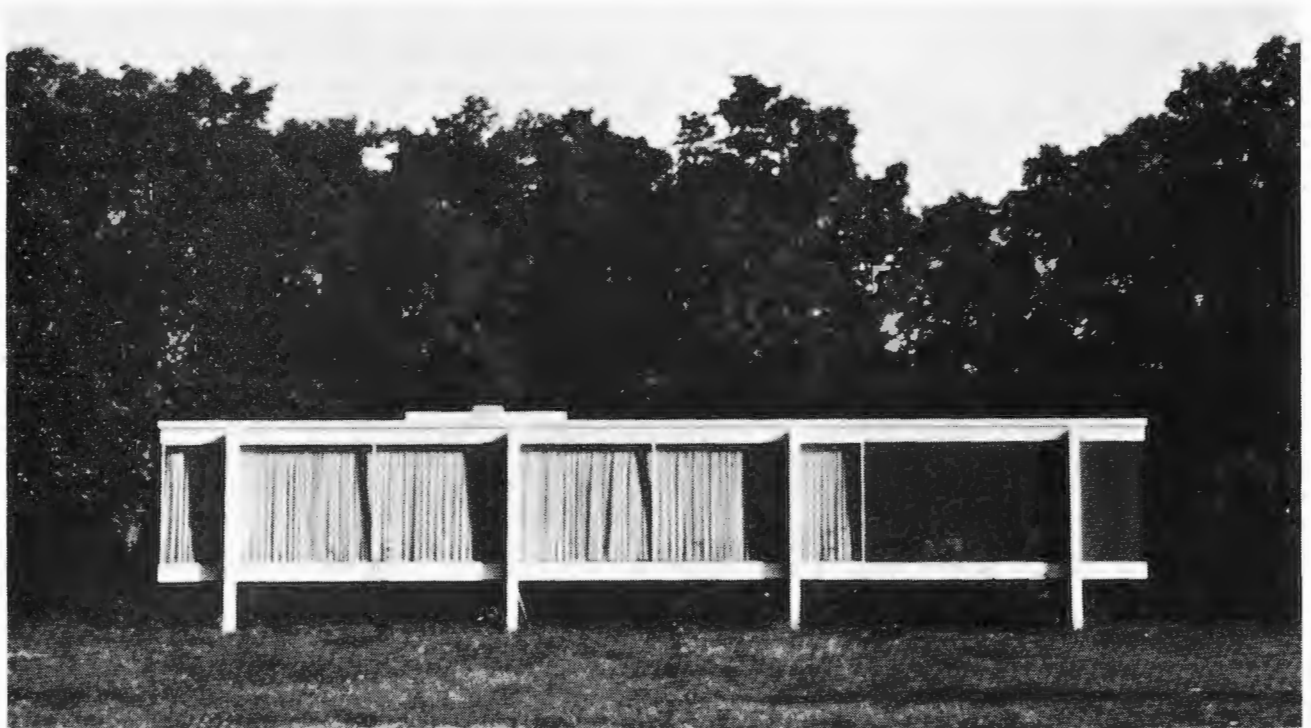

Figure 3.4

## Design Studies

---

The following design studies were developed by a number of architectural firms and architectural schools using the information presented in this manual.

### BRIDGEPORT, CONNECTICUT

With an elevation requirement of 10 feet above grade, the architects have designed these luxury townhouses around a raised central social deck (Figures 3.5 and 3.6). Parking is located beneath the deck. Access to the deck and to the townhouses is provided by stairs and a timber ramp. The ramp provides access for children, the handicapped and the elderly. During times of flooding, the ramp can also be used for driving automobiles and rescue vehicles up the deck level. Steel girders resting on concrete piers support both the social deck and the townhouses (Figure 3.7). The deck has a double floor construction, allowing added insulation and protecting utility services.

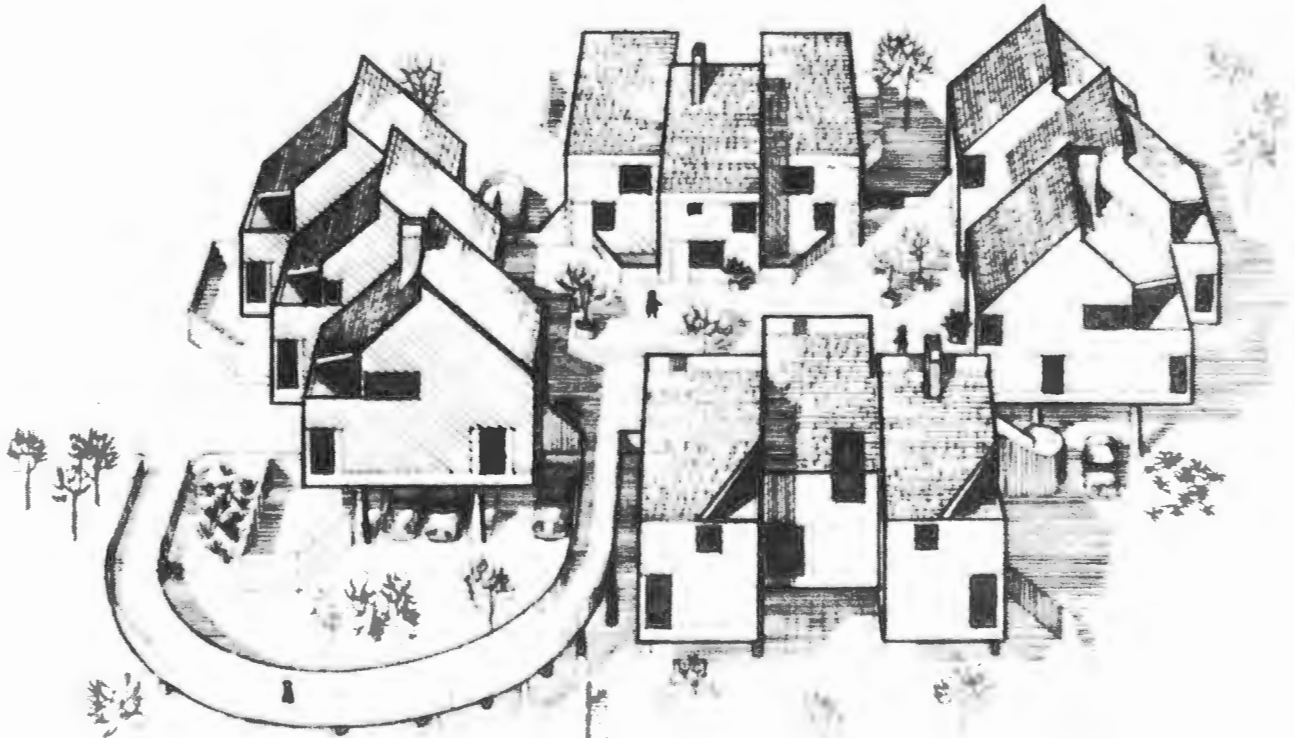

Figure 3.5

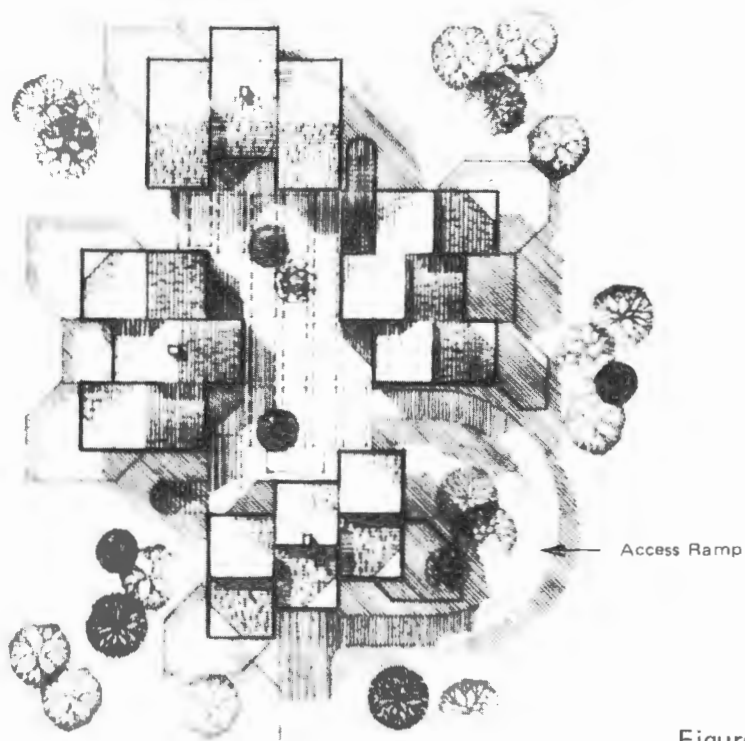

Figure 3.6

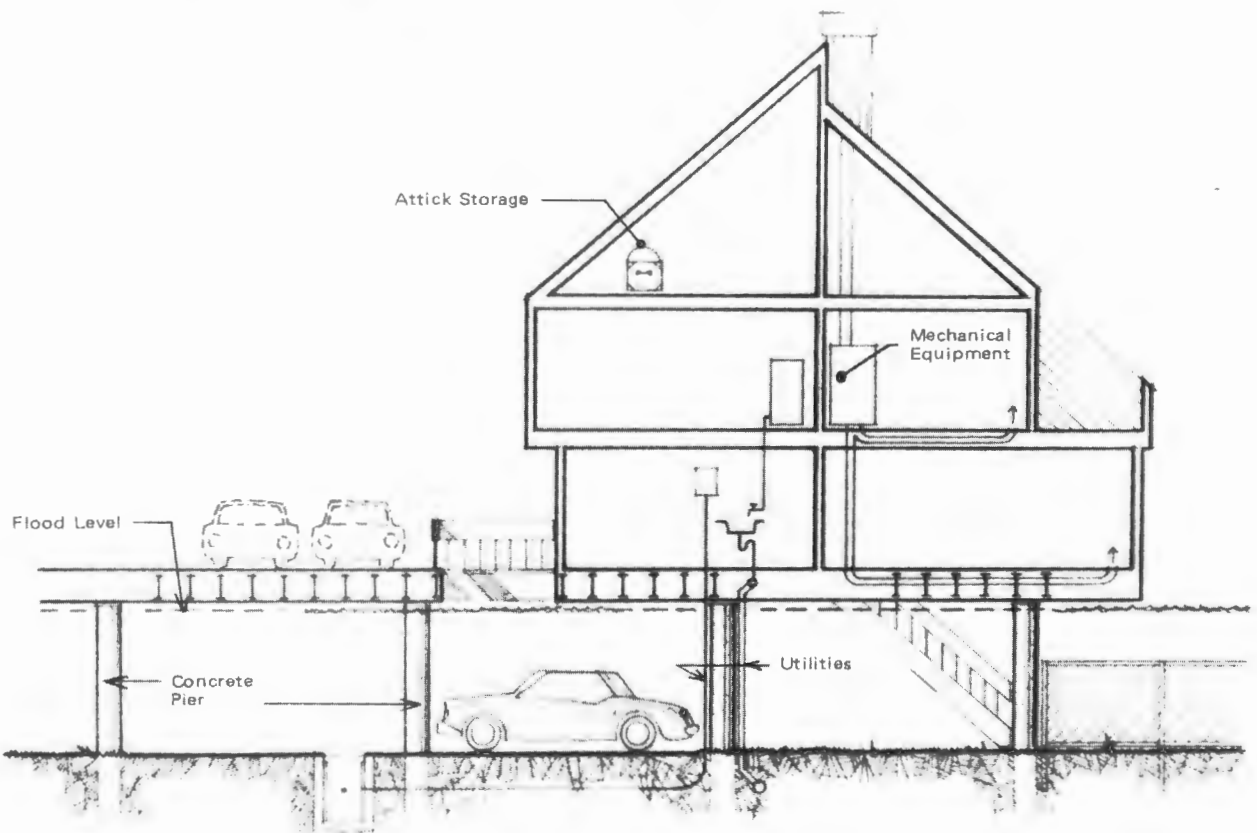

Figure 3.7

---

## CHARLESTOWN AND NEWPORT, RHODE ISLAND

The architect here has chosen two case study areas, Newport and Charlestown, Rhode Island, with distinctly different cultural and natural conditions that affect flood design considerations. Newport is a compact commercial and recreation center that has many residences along the water's edge. The area studied in Newport is a protected harbor with access from Rhode Island Sound into Narragansett Bay. The portion of Charlestown that is the second study area is a beachfront area with vacation house development. Most development is in a coastal A Zone. Both study areas have high development pressures.

In both areas historic, scenic and community values influence the design of elevated structures. In Newport the close proximity of a Historic District injects height, bulk, material, and size considerations into any planned development. (In the case of historic structures in floodplains listed on the *National Register of Historic Places* or a state inventory of historic places, restoration may be accomplished without elevating the first floor through a variance procedure.) Similarly in Charlestown, simply elevating structures, without regard for the natural environment, could produce ungainly and visually distracting elements. It is necessary in flood area design to not only meet engineering requirements, but to also be cognizant of the visual effect such design will have on the prevailing character of the area.

### Charlestown

An inventory of critical natural factors was made to determine how and where development should take place in the Charlestown floodplain. As a result, specific land area within the floodplain was deemed acceptable for residential development. The analysis then proceeded to the evaluation of methods of elevation appropriate to the development area.

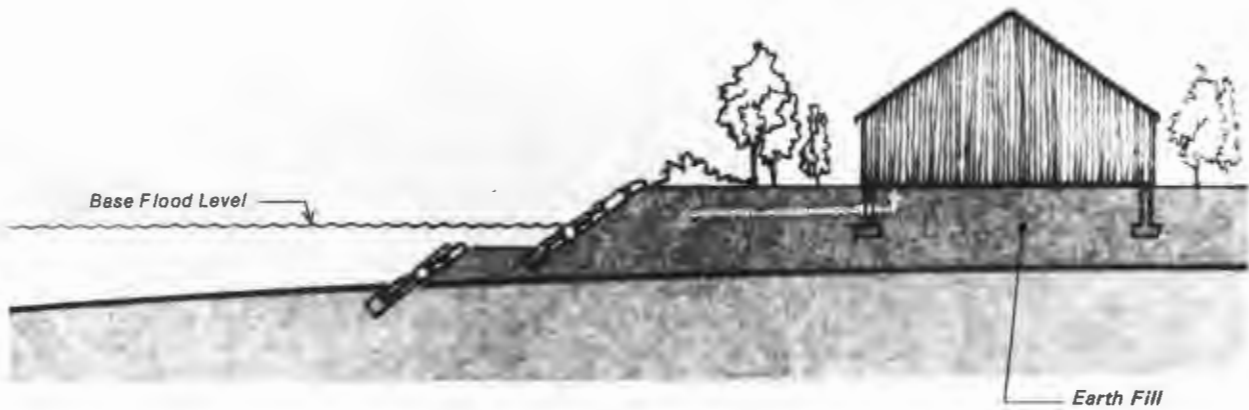

Figure 3.8

For numerous functional and aesthetic reasons, earthfill with heavy stone revetment was chosen as the method for elevating residential structures in Charlestown (Figure 3.8). The homes were clustered to keep down the cost of fill and because the land available for safe building in the floodplain was limited (Figure 3.9). A small-scale,

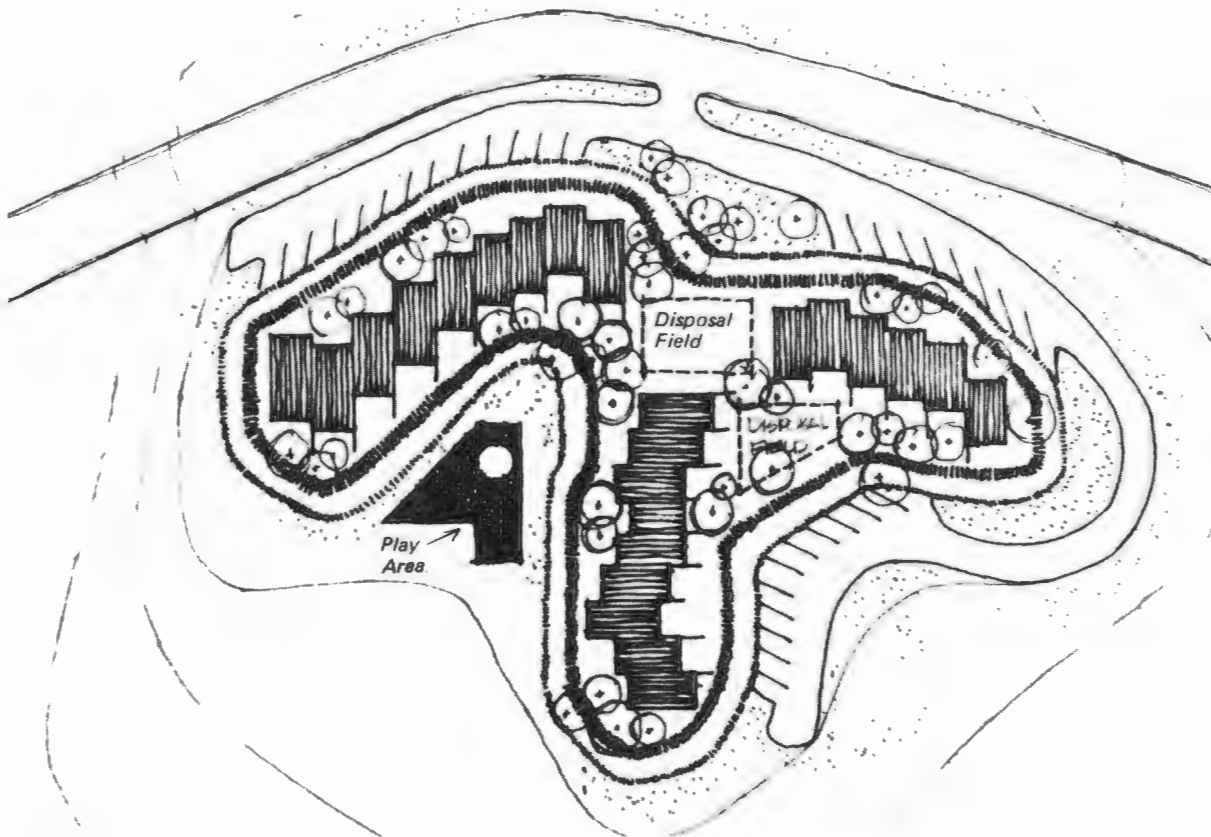

Figure 3.9



---

single-family scheme was chosen for visual continuity with earlier buildings (Figure 3.10). All houses, a small amount of private space, and all utilities are located on the common filled area. Low intensity land uses such as parking, road and driveways, playgrounds, etc., are located on the lower surrounding areas. Ramps and steps are used to accommodate the height differences from parking to the finished first floor.

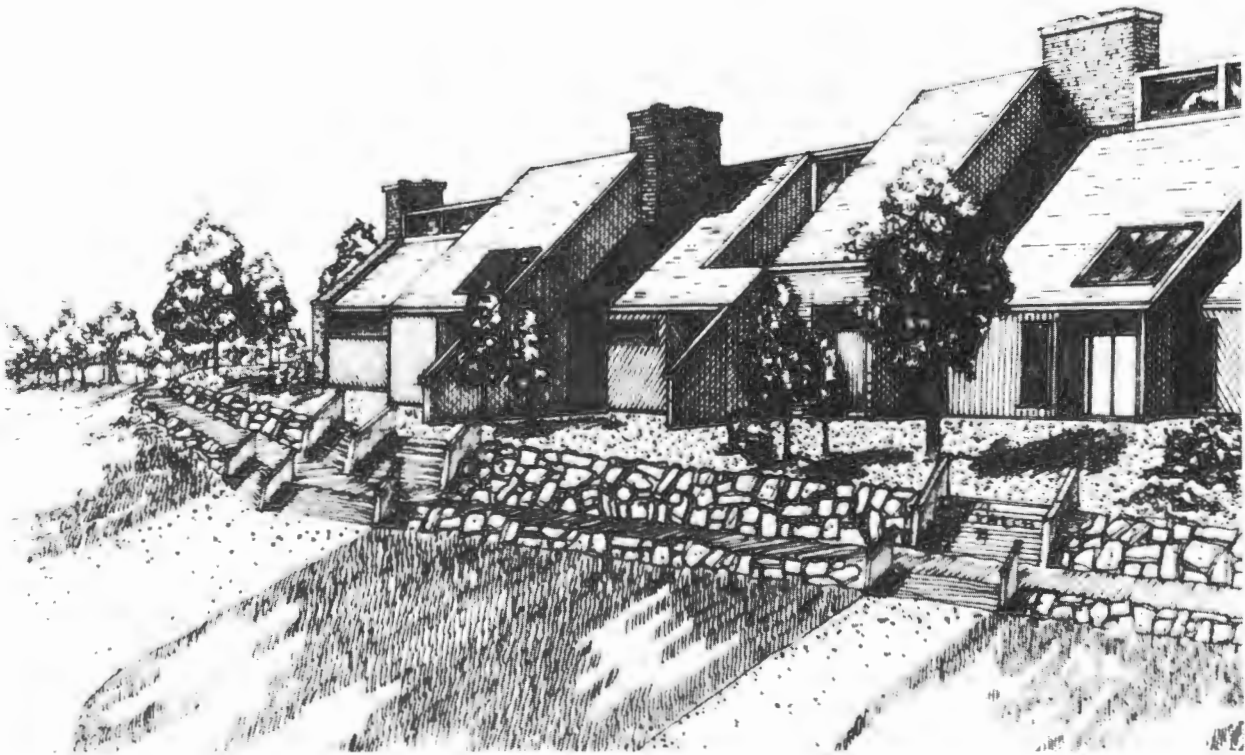

Figure 3.10

## Newport

Development in the wharf area in Newport, Rhode Island, is structured by a combination of natural and cultural conditions. Although separated from the older historic areas of Newport by a highway, its proximity to them requires special consideration of height, materials, and size. It is in a special flood hazard zone, yet its water's edge location makes it visually attractive. Changes in the use of the wharf area and its new relationship with neighboring areas have resulted in an expansion of commercial and residential development. The low height above sea level means that new structures would have to be raised approximately to the level of the highway to comply with local flood regulations. For the restoration of historic buildings, however, there is no need to elevate the first floor as long as a variance is obtained.

Analysis indicated that the optimal solution would be a combination of elevation techniques, because different zones in the wharf area are suited to different elevation strategies (Figures 3.11 to 3.13).



Figure 3.11

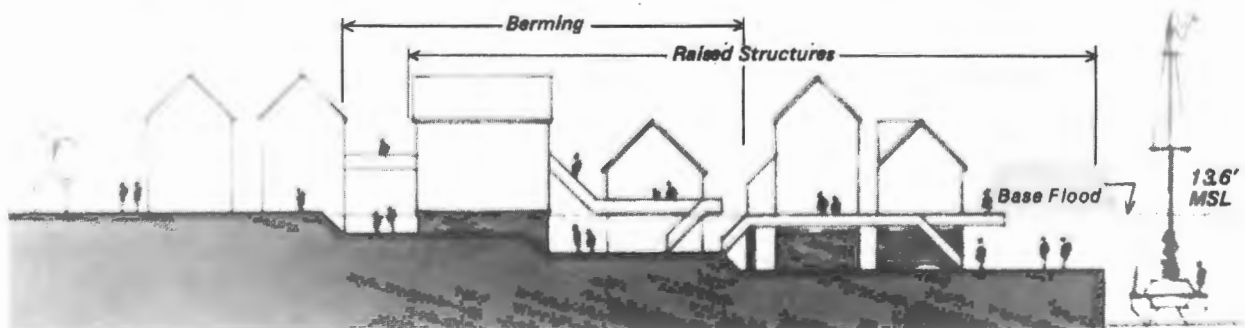

Figure 3.12



Figure 3.13

---

In the area farthest from the water, earth fill offers flood protection and a gradual level change from that of the highway. A transitional middle section could combine berming with raised structures. Level changes can be integrated by linking extended decks with ramps and stairs. In the area closest to the water, raised structures would not alter the water-to-land relationship or block views. Commercial uses are most likely to locate in the filled area, where first floor spaces are usable. Residential, restaurant, and small office uses are more suitable to the raised structures, which afford increased privacy and better views.

Spaces under and between the new buildings can be used for pedestrian malls and thus reinforce the tourist and commercial uses of the area. Decks, balconies and trellises can connect different building levels. Utilities for the raised structures could be run beneath these raised decks and trellises and then into the fill, being protected from flood damage. This manipulation of the spaces and level changes created by flood protection enhances the visual intricacy and human scale of the wharf.

---

## SAN FRANCISCO, CALIFORNIA

Pacific coast flooding is generally associated with high seas and rains. Ocean storms accompanied by high winds have caused considerable erosion and damage to beach and coastal floodplain property. Inland rain storms, on the other hand, falling on the mountainous terrain cause major canyon and valley flooding. Both coastal and canyon flooding are dangerous high-velocity situations. Slow-rising and lower-velocity conditions occur on coastal marshes and low-lying riverbeds.

The architect has developed several very interesting and distinctive residential concepts for single- and multi-family housing. The use of landscaping, fences, and exterior decks minimizes the elevated appearance of the structures while providing functional visual highlights. Structurally the two concepts are quite different. Although both concepts use wood posts, the single-family residence uses a two-way structural grid supporting prefabricated housing units, while the multi-family structure is conventional wood frame construction built upon a wood-post-supported platform.

Parking for both residential concepts is under the structure.

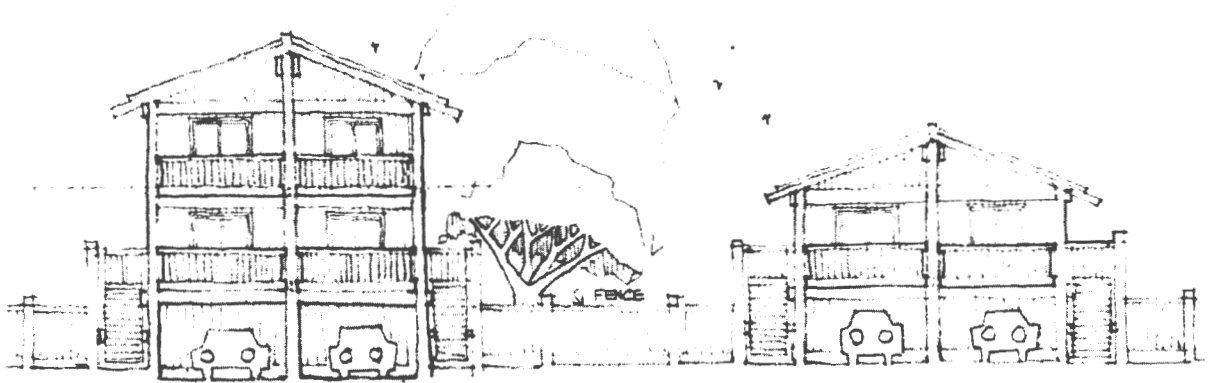

Figure 3.14

---

## Single-Family Residential Concept

A two-way wood post structural grid supports the living units at levels above the base flood and serves to organize and unify the various units with minimal impact on the ecology of the area (Figures 3.14 to 3.16). A seven-foot clearance beneath the horizontal structural members allows for parking, storage, and sheltered recreation space separated from and below the living units. The reduced land coverage of this design is in keeping with the architect's concern for efficient land use. Shared facilities, clustering buildings, etc., further give these houses a unique identity and sense of community. Within the prescribed vernacular of poles, decks, railings, and fences, architectural variety with continuity is achieved. The fences are strapped together to prevent pieces from floating away if damaged during a flood. Water heater and furnace and air conditioning equipment are located 18 inches above base flood level with all ductwork in second floor or attic space.

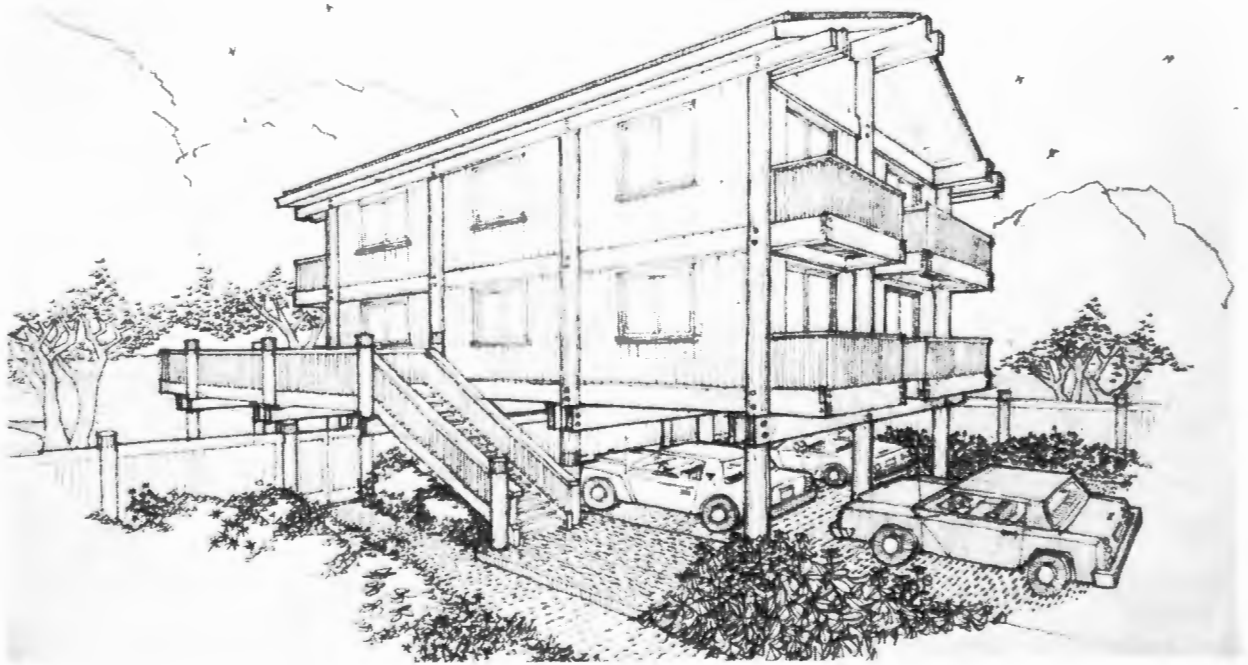

Figure 3.15

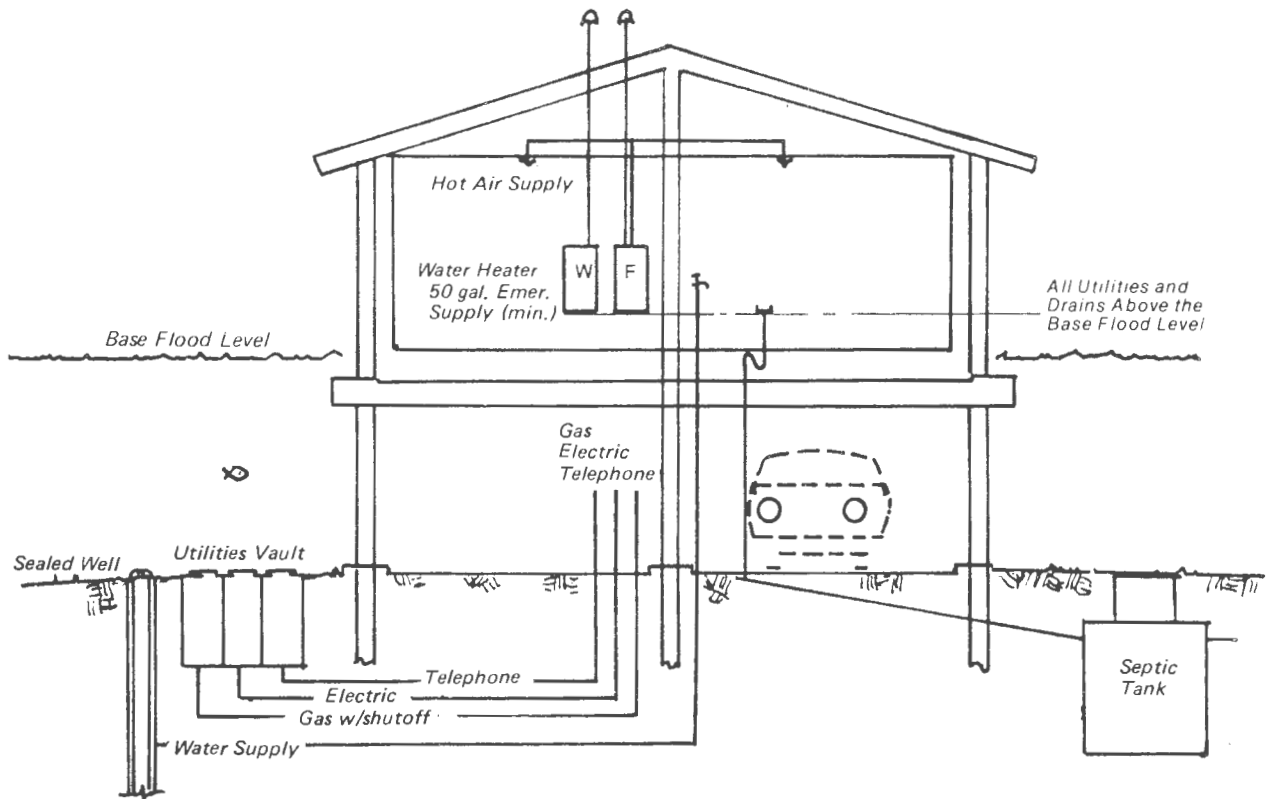

Figure 3.16

---

## Multi-Family Residential Concept

To reduce costs, the architects have designed a conventional wood frame structure built upon a wood post platform (Figures 3.17 and 3.18). Raising the first floor to at least eight feet above grade provides an opportunity to put parking under the building. This reduces the area of the site that has to be built upon and places cars closer to apartments. However, parking under the structure requires fire separation. Exposed entrance stairs and fencing minimize the elevated appearance of the structure while providing visual variety and privacy.

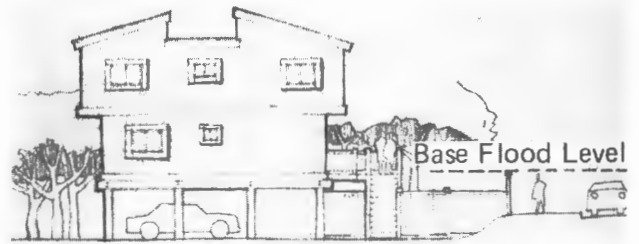

Figure 3.17



Figure 3.18



## CHICAGO, ILLINOIS

Flooding in the Midwest is of two types: riverine and lake flooding. The characteristics of both are usually slow rise and low velocity. However, flash flooding and lake shore scouring can and do occur. The Great Lakes area, more specifically, the Wisconsin, New York, Ohio, and Michigan lake shores, have experienced growing problems of lake flooding and slow erosion caused by the increasing occurrence of high waters and high winds.

### Garden Apartment Concept

Although elevated eight feet and constructed of reinforced concrete block, this rowhouse does not appear to be designed for a potential flood condition (Figures 3.19 and 3.20). The covered parking and entrance level is handsomely integrated with the above living levels by reinforced concrete block walls that organize the entire structure. The walls are constructed parallel to the direction of possible water flow. Unfortunately, the architect enclosed the stairway-entranceway, with a potentially serious effect on flood insurance rates.

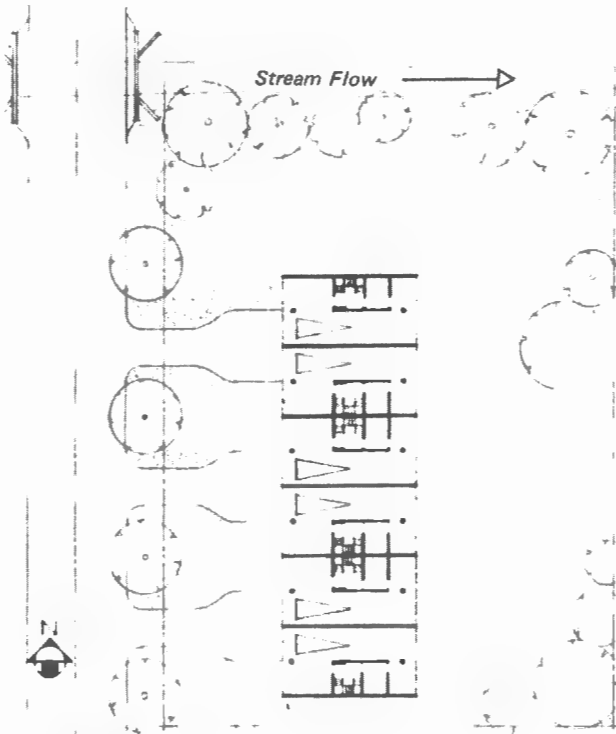

Figure 3.19

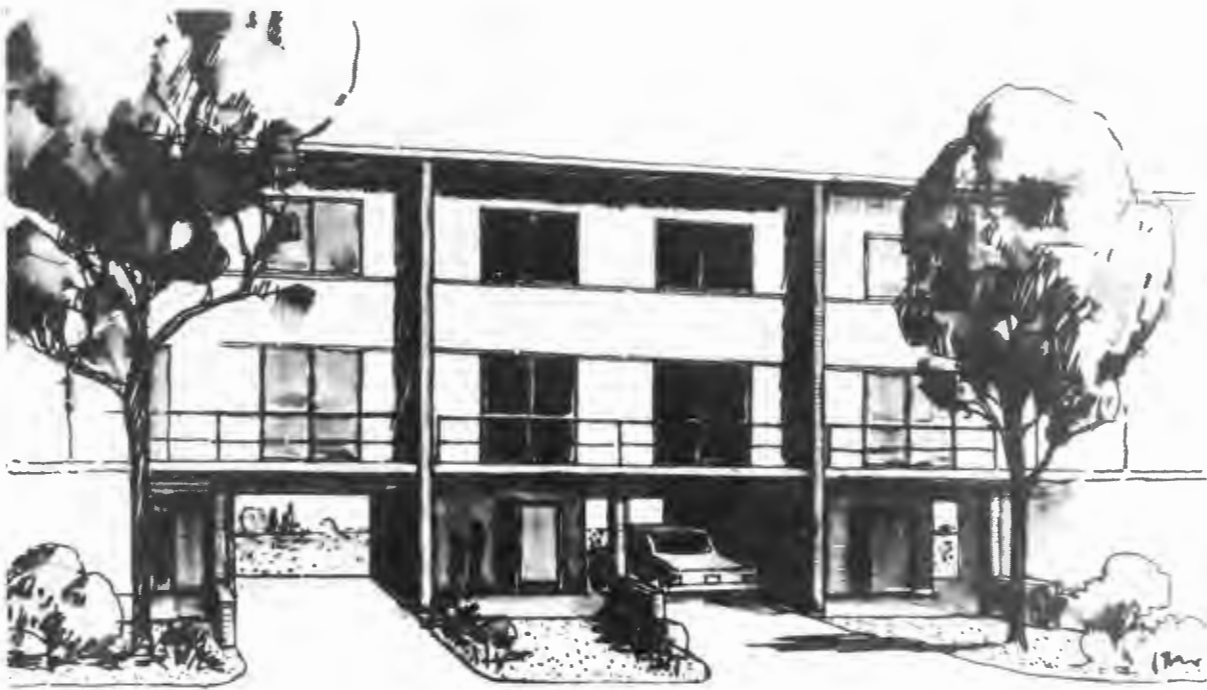

Figure 3.20

## Aesthetic Considerations

---

There is a common misconception that an elevated residential structure will be inherently unattractive—a box on stilts (Figure 3.21). This is not true. Elevated structures offer challenging design opportunities to be aesthetically appealing as well as functionally sound.

Residential development requires a significant financial investment, and if it is aesthetically appealing it contributes to the economic value of the area, both for the owner and for the community as a whole. All communities have both positive and negative examples of this. Good quality tends to foster better quality, and poor conditions lead to even poorer conditions. Appealing design can thus be an important element of making the most of our limited development resources.



Figure 3.21

## SITE DESIGN

Integration of development and site should be done so that the two complement each other. A careful site analysis can give many clues to the best design of the building for its relation to topography, location and orientation, and location of fenestration (views, etc.), entries, and parking.

Landscaping—creative use of trees, shrubs, fences, walls, etc.—serves two purposes. It integrates the elevated portion of the development with its surroundings and, at the same time, helps control erosion and protect the dwelling from the impact of debris and fast-moving water (Figures 3.22 and 3.23).

The relationship and compatibility of development with the surrounding neighborhood and community should be considered in order to give a sense of continuity with the surrounding areas, rather than an unattractive “hodge-podge” of unrelated development.

Terracing and level changes can be used to give a sense of variety and to identify different uses, as well as to integrate building with site.

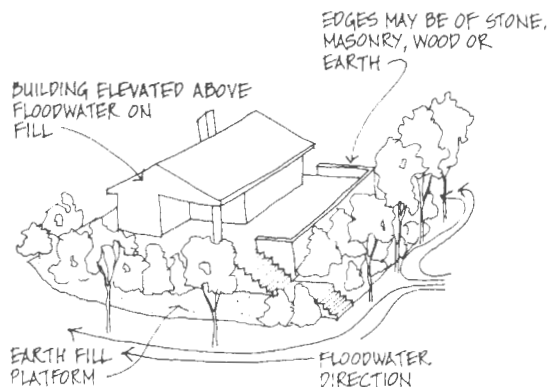

Figure 3.22

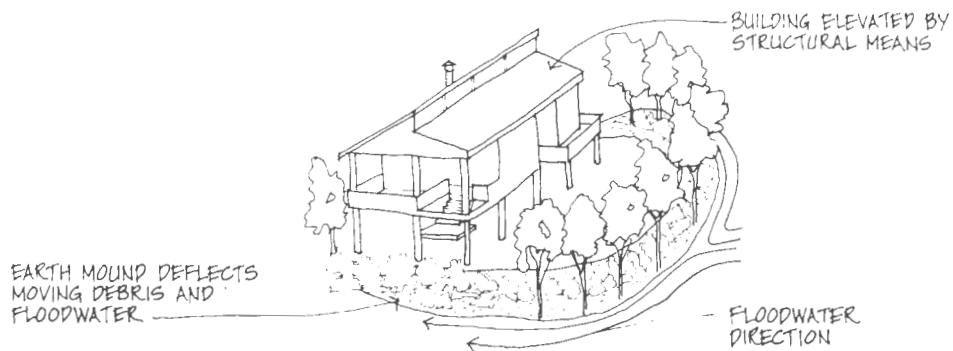

Figure 3.23

---

## BUILDING DESIGN

The integration of the foundation with the site and the building is perhaps the most important aesthetic challenge when designing elevated structures. Many elevated structures give the impression that the support foundations are treated separately from the building and the site, giving the impression of a building set on spindly legs (figure 3.24). It is essential to recognize that the foundation is an integral part of a building, rather than only “something to set the building on.” A well-designed elevated residence should provide a smooth transition from ground to dwelling, with the foundation integrated with and complementary to the building itself.

Other special considerations when designing elevated residences include the design of any needed stairs and the use of the areas under the structure. More general considerations include the shape and form of the building (configuration, shape of roof, etc.), textures and color of building materials, the use and treatment of balconies, terraces, railings, windows, shutters, screens, and entries, and the arrangement of interior spaces.



Figure 3.24



Figure 3.25. This wood structure successfully uses the same material throughout the building—foundation, structure, treatment of railings, wall, and roof material, as well as connection and anchorage details. The design honestly expresses the structure, foundations and other building elements. While it is obvious this is an elevated structure, it still feels very much a part of the site. The foundation members are also integrated well with the building itself (see also Figures 3.54 to 3.57).

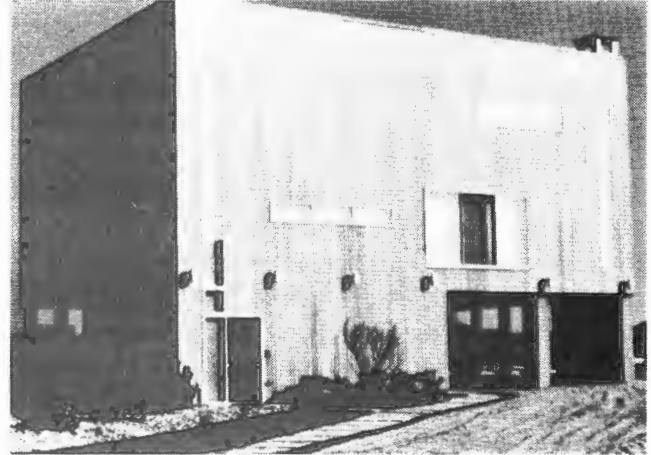

Figure 3.26. This is an example of integrating the site, the building, and the foundation so they relate well to each other. This foundation appears to be part of the building rather than stilts holding it up. It shows how a modest, simply designed building can also be very aesthetically appealing through the use of natural materials and interesting treatment of fenestration and lighting fixtures. Simple but well-thought-out landscaping ties the building effectively to the site.



Figure 3.27. This is a good example of how the configuration of a cluster layout can contribute to functional advantage as well as visual appeal. The sawtooth arrangement allows for two sides of each unit to have access/view to the ocean. This form also breaks up the long, continuous (and often monotonous) wall approach, thus adding variety and interest. With this configuration the materials, treatment and form of the units can be simple but still attractive.



Figures 3.28 to 3.29. This is an excellent example of cluster-type elevated residential development. The development is well-integrated with the site; the various levels seem to roll over and blend with the dune. The vegetation and simple fencing add much to this marriage. The individual units also relate very well to each other, providing a good example of an overall development's being "more than the sum of its parts." The individual units provide the individual amenities—privacy, plan layout, etc.—while still being a part of a comprehensive whole with a strong sense of community. The form, scale and character of the development are also excellent. The sloped roofs, the balcony treatment, use of levels, and the articulation of the other elements add variety and a character that complements the site and overall development. The use of materials—color, texture, scale—also contributes to the design's appeal (see also Figures 3.63 to 3.70).



Figure 3.30. The exterior treatment of this development adds visual appeal to a development that could otherwise be quite monotonous. The exterior colored panels with white structure and coordinated interior panels provide interest, as does the simple treatment of balconies with a variety of planes, panels, railing and roof trellis members.



Figure 3.31. This is a good example of how a simple structural grid infrastructure can be used as a basis for a relatively modest, well-designed and visually appealing residence. The plan is simple, developed around the columns, but provides a very livable, interesting and functional space. The cantilevered balconies also add interest as well as defined exterior areas. The roof shape contributes to a spacious interior that makes the house feel larger than it really is, allows in natural light through the transom windows, and through its form adds much to the overall aesthetic appeal of the design (see also Figures 3.40 through 3.45).





Figure 3.32. The diagonal battens used to enclose the stairwells for protection provide an aesthetically appealing screen-textural affect. The colored awnings also add a necessary highlight to an otherwise colorless exterior. Notice also the pole light fixture.

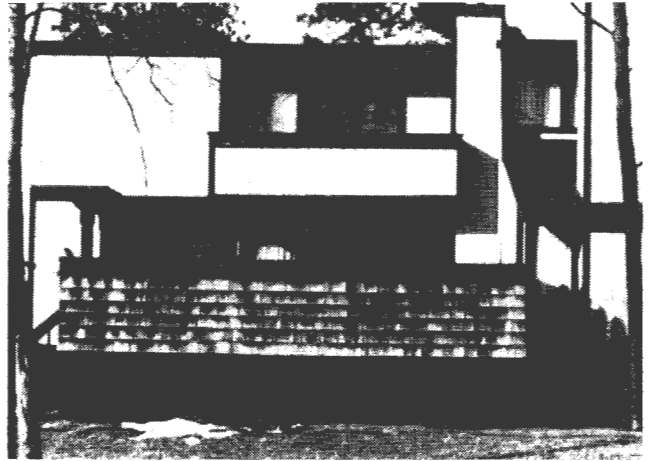

Figure 3.33. Passersby have to look very carefully to see that this development is actually elevated. Good use of landscaping and building form includes attached and detached units.



Figure 3.34. This structure uses a mixture of materials, texture and color very successfully and provides a variety of form for visual appeal. The space under the building remains open and light through a combination of white unobstructed walls and piers, landscaping, and layout relative to other buildings. A human scale is accomplished by breaking the building up into different heights and sections, rather than an imposing three-story box, as is often done (see also Figures 3.58 through 3.62).





Figures 3.35 and 3.36. This is a good example of using a variety of shapes and forms (wall surfaces, planes, balconies, etc.) as well as wall treatments (materials, texture, color) to create a sense of variety essential for an aesthetically pleasing development.





Figure 3.37. In the interior, color, scale, texture, and floor arrangement must be given careful attention (see also Figures 3.40 through 3.45).



Figures 3.38 and 3.39. Well-designed elevated residential structures can take many forms and styles. The principles in this manual are applicable to any style.

## Recent Design Examples

---

The projects in this section are some of the best design examples discovered in a state-of-the-art survey conducted as part of the development of this manual. While these examples range from a single-family detached unit to a multi-family high rise, there appears to be a clear trend toward higher density, cluster-type development. This is probably due to higher land values and the experience gained from major floods over the last couple of decades. This is a promising trend that encourages professional design involvement in residential structures and leads to a more comprehensive approach to elevated residential and other development in flood-prone areas.

Virtually all the recent design examples that were submitted in response to our survey were coastal, as opposed to riverine, projects. This suggests that the state of the art is being set for the most part in coastal areas, especially in the higher-use resort areas. It should be noted, however, that what is being done in coastal areas can often be applied successfully in riverine, lake, and other flood-prone areas as well.



Figure 3.40

## THE LOGAN HOUSE

Tampa, Florida

Architects: Rowe Holmes Barnett

Architects, Inc., Tampa, Florida

The Logan House (Figures 3.40 to 3.45), located adjacent to a federally protected tidal estuary near Tampa, Florida, exemplifies a skillful blend of flood protection and energy conservation. The natural site of the house, only four feet above sea level, suggested the possibility of flooding. Flood regulations required Rowe Holmes Associates to elevate the structure an additional six feet. They chose, however, to raise the house almost eight feet to be able to use the first level as both a carport and protected outdoor living area.

The 2,000-square-foot structure is designed in what is known in Southern vernacular as the “dog trot” style, incorporating a long breeze-way/ventilating device covered with the same roof as the house but open on the sides. The wood frame house is supported on 10-inch-square pressure-treated pine poles augered deep into the soil to withstand hurricane forces common to this area of the country. The floor serves as a horizontal diaphragm to provide the pole structure additional rigidity.

Several of the features that protect the Logan House from flood damage also promote energy conservation. For example, elevating the structure, the major flood protection strategy, helps draw cool (lower) air up and through the house.

A central utility core—unfortunately located on the lower level where it is vulnerable to storm forces—is serviced by a stairway, allowing protected access to the carport and outdoor space.

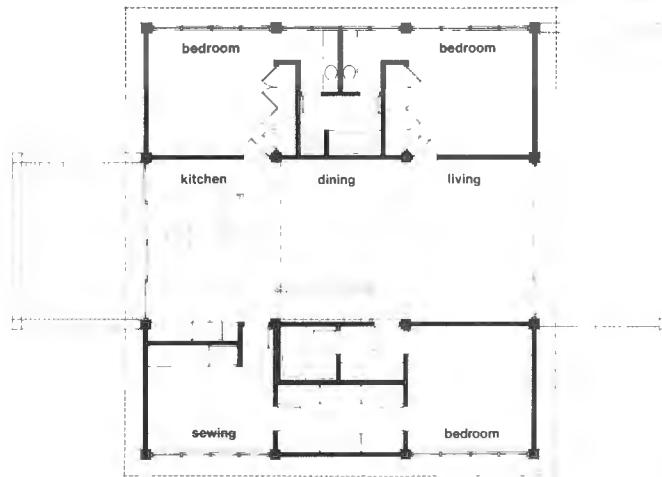

Figure 3.41

living level

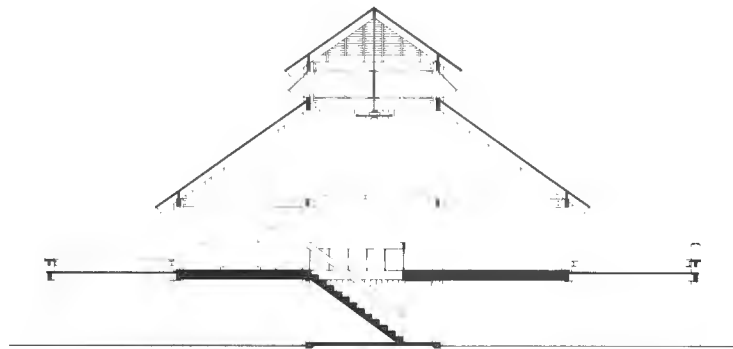

Figure 3.42

section

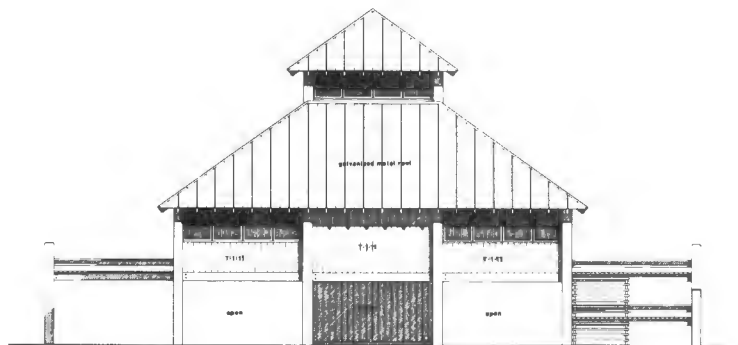

Figure 3.43

south elevation





Figure 3.44



Figure 3.45

---

## SUMMERWOOD ON THE SOUND

Old Saybrook, Connecticut

Architects: Zane Yost & Associates, Inc.,  
Bridgeport, Connecticut

Summerwood on the Sound (Figures 3.46 to 3.50), a 76-unit cluster development, won a 1979 design award for architects Zane Yost & Associates, Inc. The development is built on a peninsula tidal estuary protected by a barrier beach.

Equal in importance to protecting the buildings from flooding was the preservation of the salt marsh ecological environment. For this reason, the architects chose to locate the units only along the natural contours of the 30-acre site. For further protection of land as well as buildings, the structures are elevated above flood level, topping crawl spaces with internal drains to permit flood water to pass in and out. The wood frame structures are covered with horizontal siding and use picket fences to soften the effect of the raised structures. Redwood stairs and decks adorn the water side of the units.

Although the overall density on the site is low (2.5 units/acre), the clustering of the units makes for a comfortable neighborhood scale.



Figure 3.46



Figure 3.47



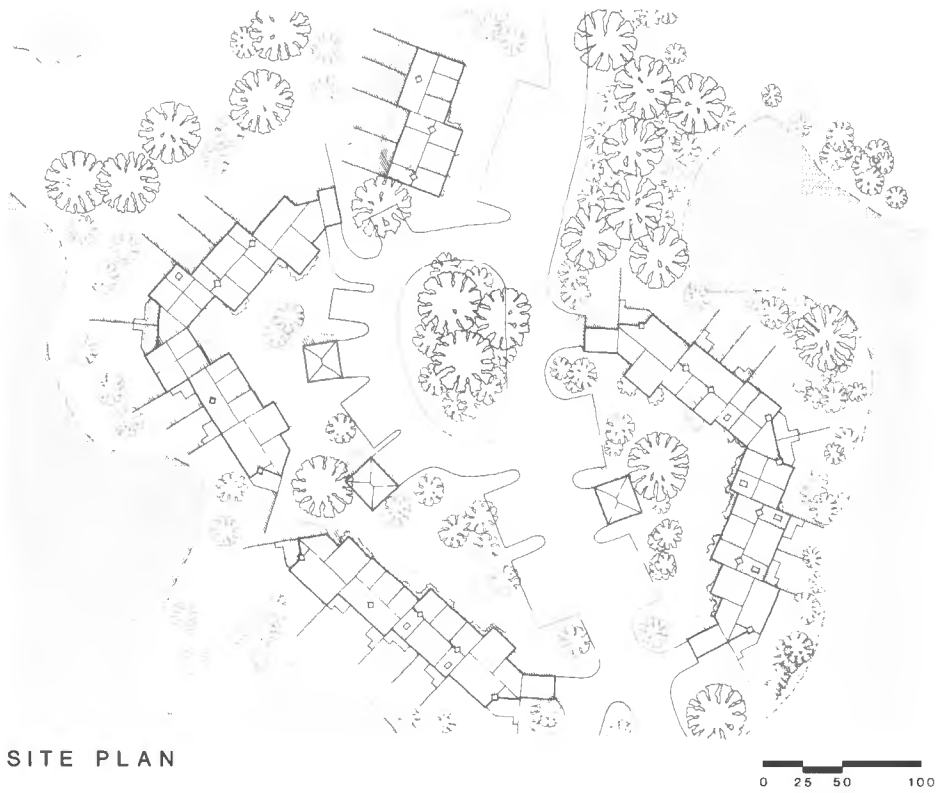

Figure 3.48

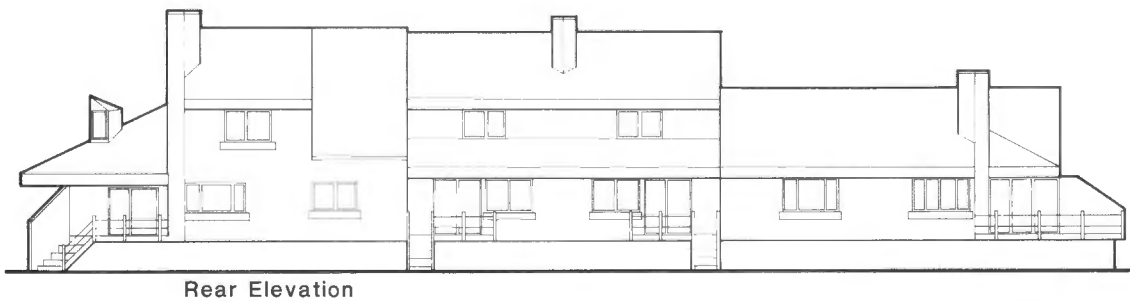
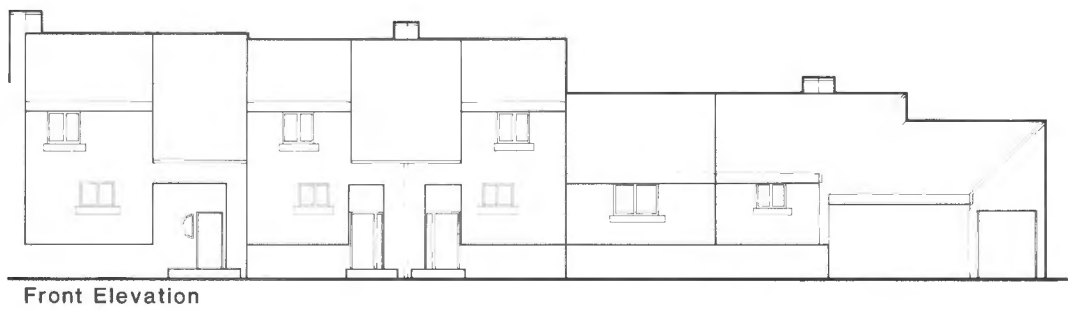

Figure 3.49



Figure 3.50

---

## THE BREAKERS CONDOMINIUM

Redington Beach, Florida

Architect: Rowe Holmes Barnett

Architects, Inc., Tampa, Florida

The Breakers Condominium in Redington Beach, Florida (Figures 3.51 to 3.53), is composed of 38 two-bedroom units oriented to take advantage of a spectacular ocean view. Using a “double saw-tooth stepback” plan, the architects oriented the buildings around a communal atrium garden, creating a pleasant internal garden on an otherwise flat and treeless site.

The 1,200-square-foot units, completed in 1973, are composed of exterior masonry walls and flat-slab and column construction to reach a height of 12 feet above sea level, which is the 100-year high flood elevation. A heavy Spanish stucco finish and louvered privacy screens made of red-wood soften the effect of the typical condominium construction.

All the units share the atrium garden on either their entry or walkway sides. The units also share a game room and beachside pool and deck.



Figure 3.51

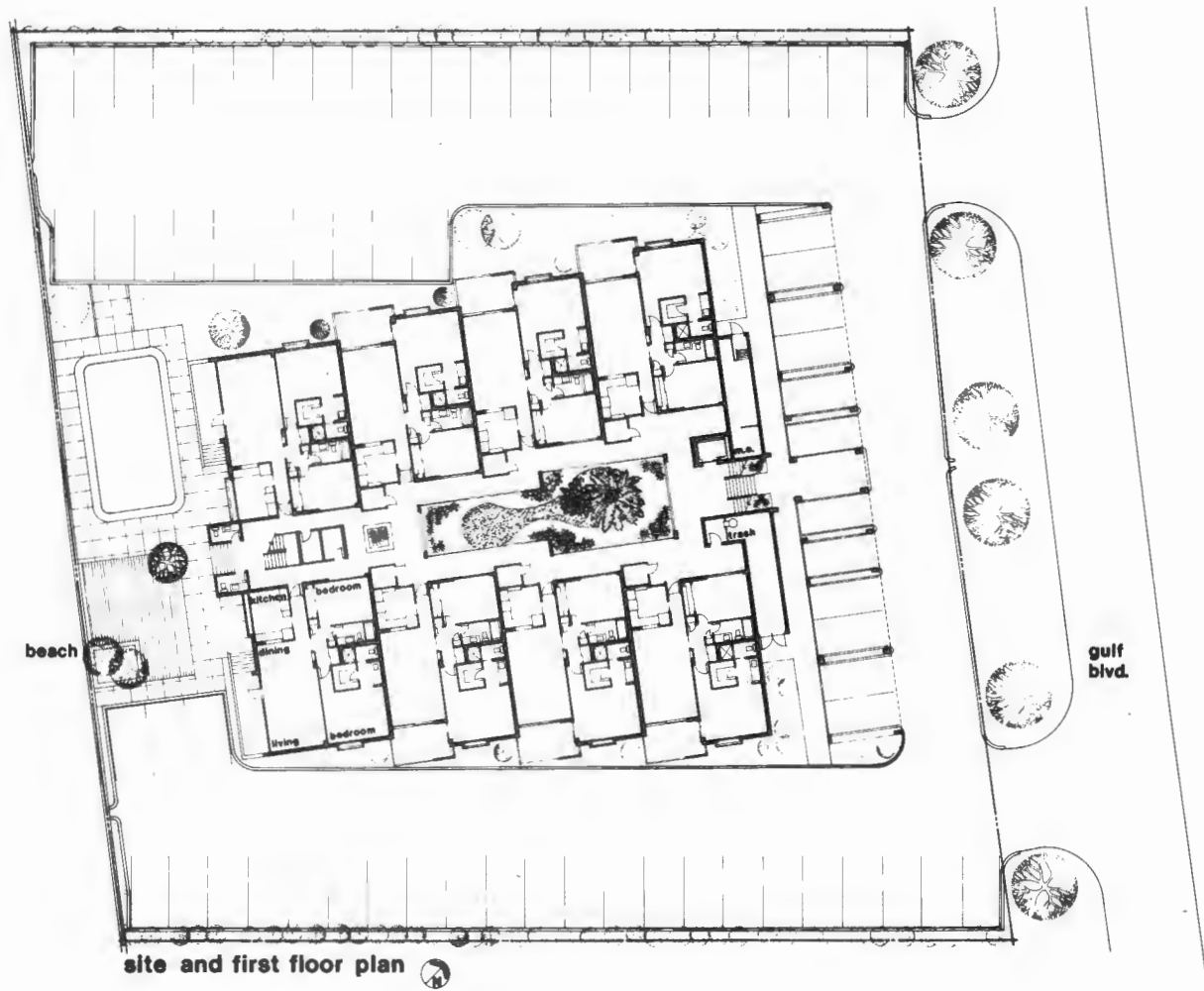

Figure 3.52

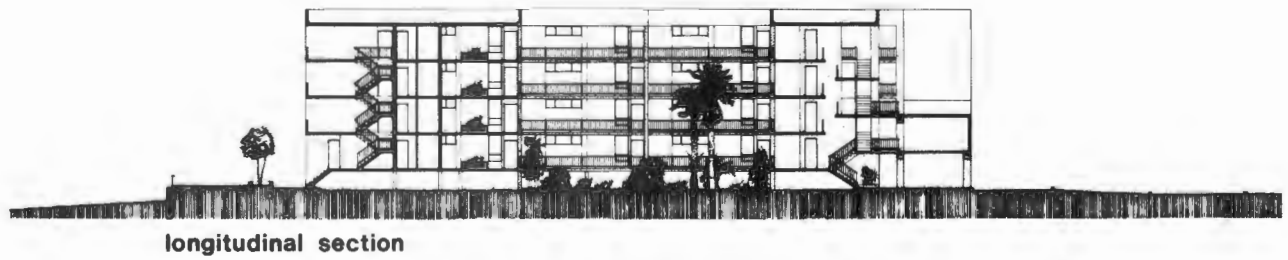

Figure 3.53

## CAMPUS-BY-THE-SEA FACILITY

Catalina Island, California

Architect: Leonard E. Lincoln, AIA,  
Palo Alto, California

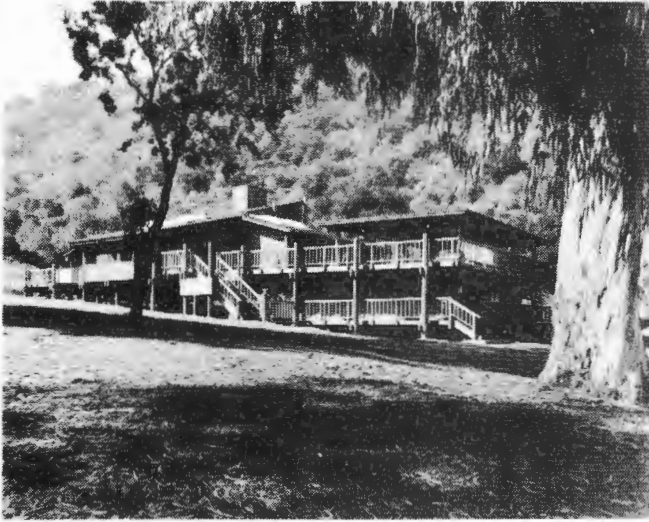

Figure 3.54

Catalina Island (Figures 3.54 to 3.57), developed as a resort center in the 1920s, is located 21 miles off the coast of southern California. Many of the original structures built on the island were destroyed by flash floods in 1980 when storm waters cascading down a series of ravines swept them off their concrete pier foundations.

The newly replaced key facilities of Campus-by-the-Sea, a conference center, are no longer threatened by such flooding. For example, the new three-level dining complex makes use of poles that serve as both foundation and roof support for the 7,000-square-foot structure. The structure is supported by 55 poles, ranging from 25 to 40 feet in length. These poles are set on concrete pads, which were poured at the base of 10-foot-deep caisson holes. The poles were specially pressure-treated to resist decay and termite attack. A preservative (pentachlorophenol) was carried by a low-viscosity petroleum gas, allowing for deep penetration through the sapwood into the heartwood.

Several of the new two-unit cabins on the site have also used this kind of structure, and more similar construction is expected to take place in the near future.

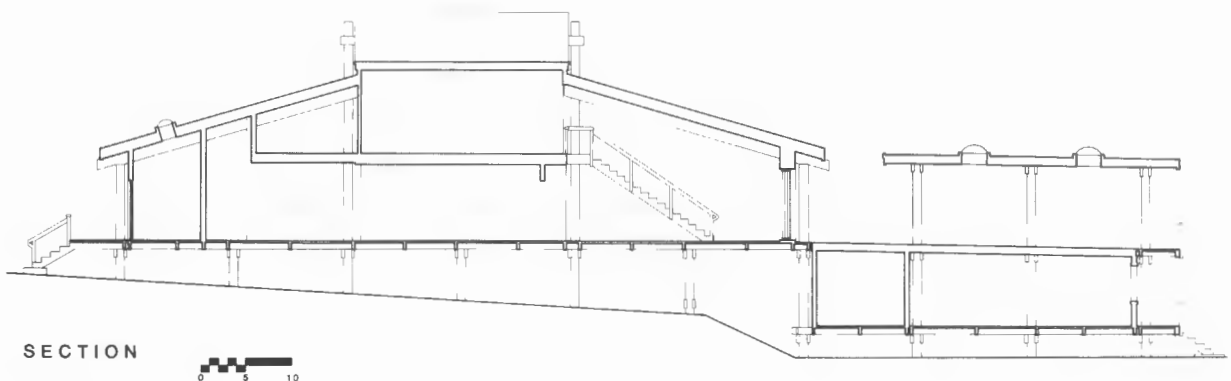

Figure 3.55

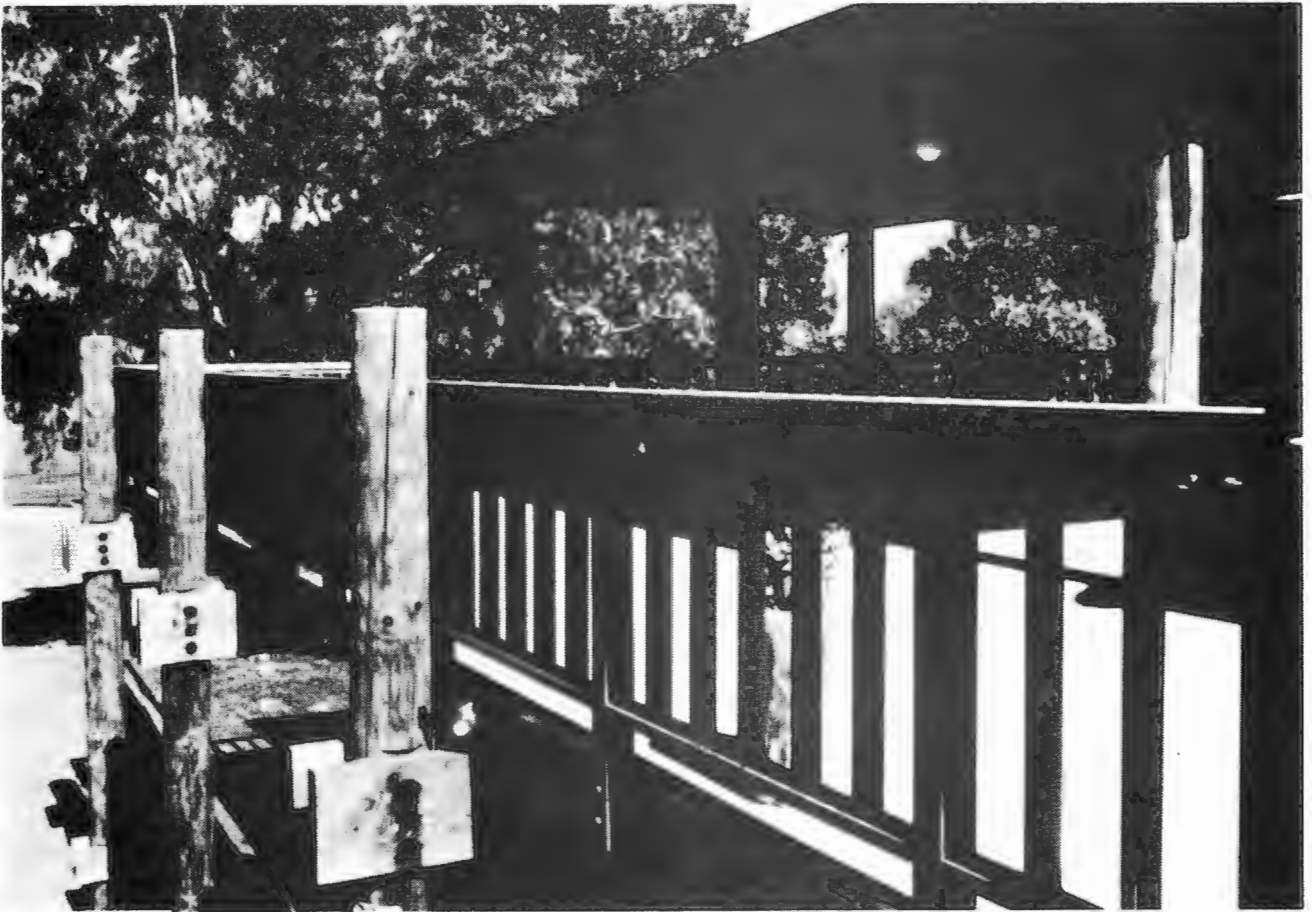

Figure 3.56

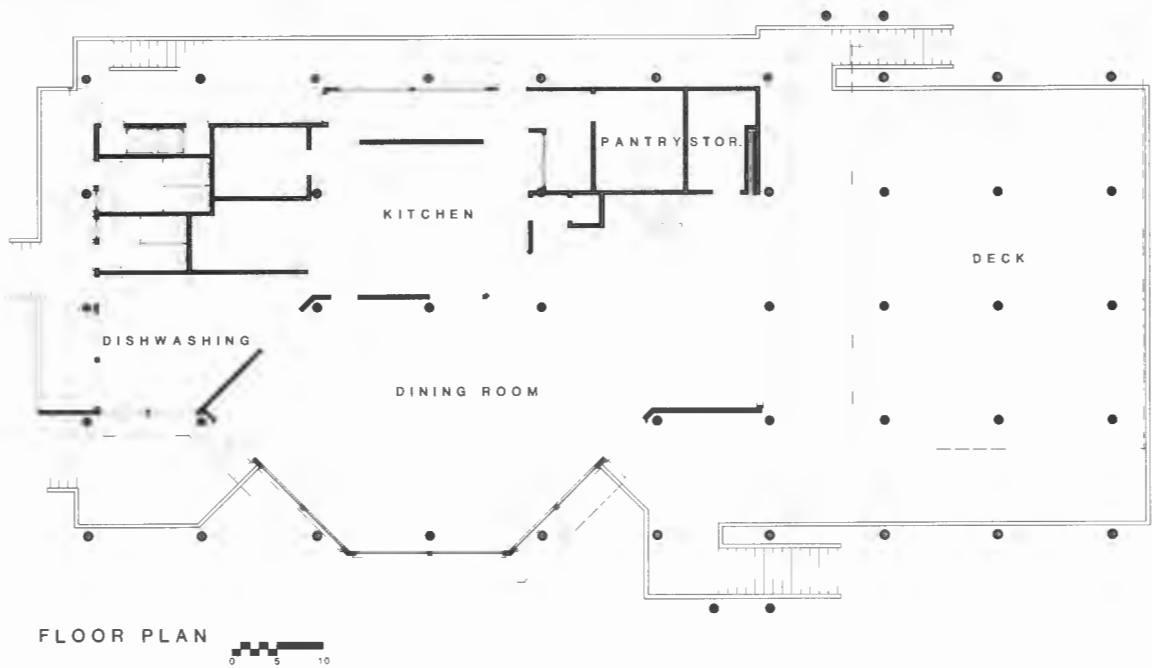

Figure 3.57

---

## STARBOARD VILLAGE

Pensacola Beach, Florida

Architects: Davis & Associates,  
Architects & Planners, PA,  
Orlando, Florida

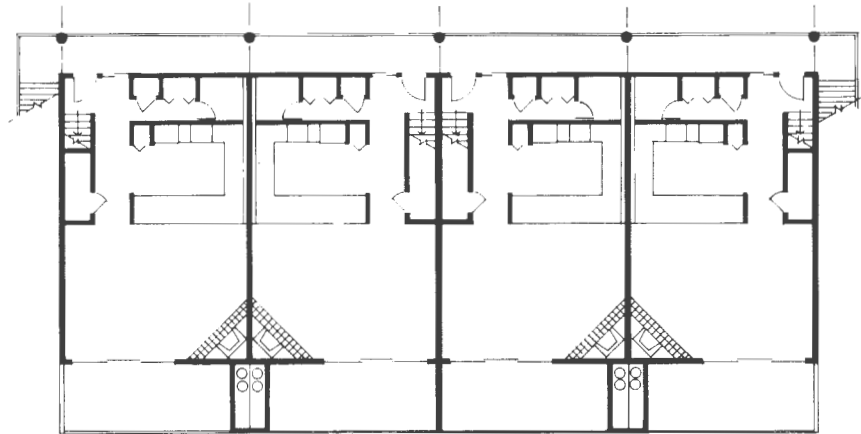

Figure 3.58

Starboard Village (Figures 3.58 to 3.62) is a 33-unit condominium project consisting of six low-rise buildings on the Gulf of Mexico. All the living areas are raised above grade, allowing parking at ground level. Each building is designed with a module using a one-story unit with two-story units above. All structures are concrete frame and slab systems, supported on concrete-piling with shear walls designed to withstand hurricane forces. Wood-accented stucco as the primary finish maintains a residential quality. The architects exercised special care in locating the air-conditioner units, mounting them under concrete stairs and on the underside of the second floor concrete slabs. Wood louvers then enclose the units. Wood louvers then enclose the units.



Figure 3.59



TYP. FLOOR PLAN



Figure 3.60

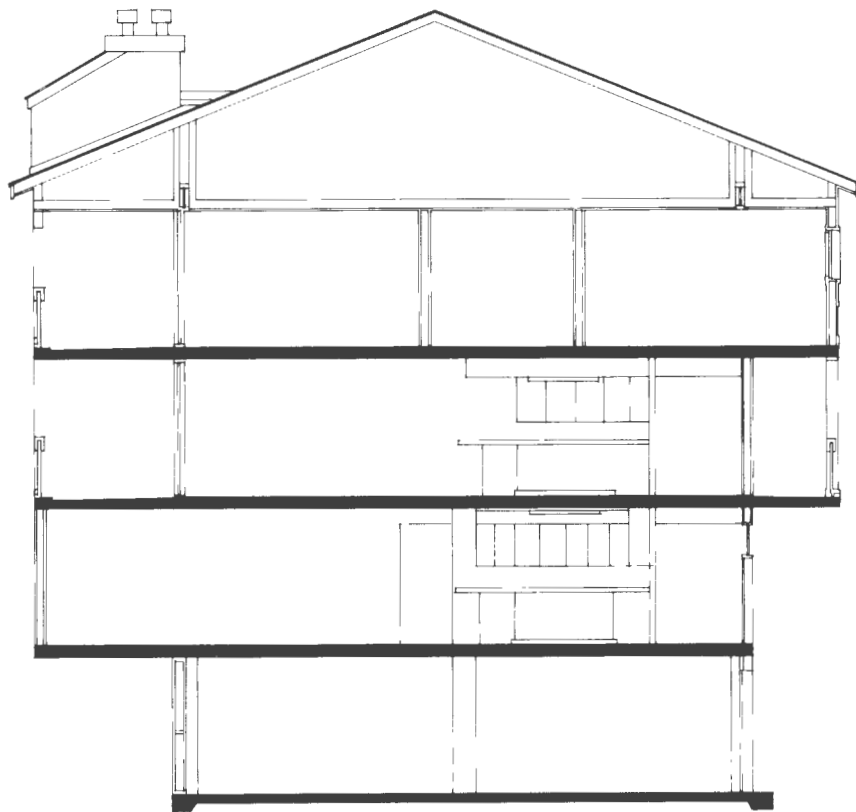

SECTION



Figure 3.61





Figure 3.62

---

## GULL POINT CONDOMINIUMS

Perdido Key, Florida

Architects: H. Shelby Dean—Richard H. Fox,  
Architects, Anniston, Alabama

The design of this 16-unit condominium (Figures 3.63 to 3.70) on the Gulf of Mexico successfully integrates storm protection, energy conservation, function, and economics.

The architects used pile construction to elevate the units several feet above the minimum required by the National Flood Insurance Program. This was done because analysis of the flood insurance premium rate structure showed that the added margin of safety from the additional elevation would qualify the units for significant savings in annual insurance costs.



Figure 3.63

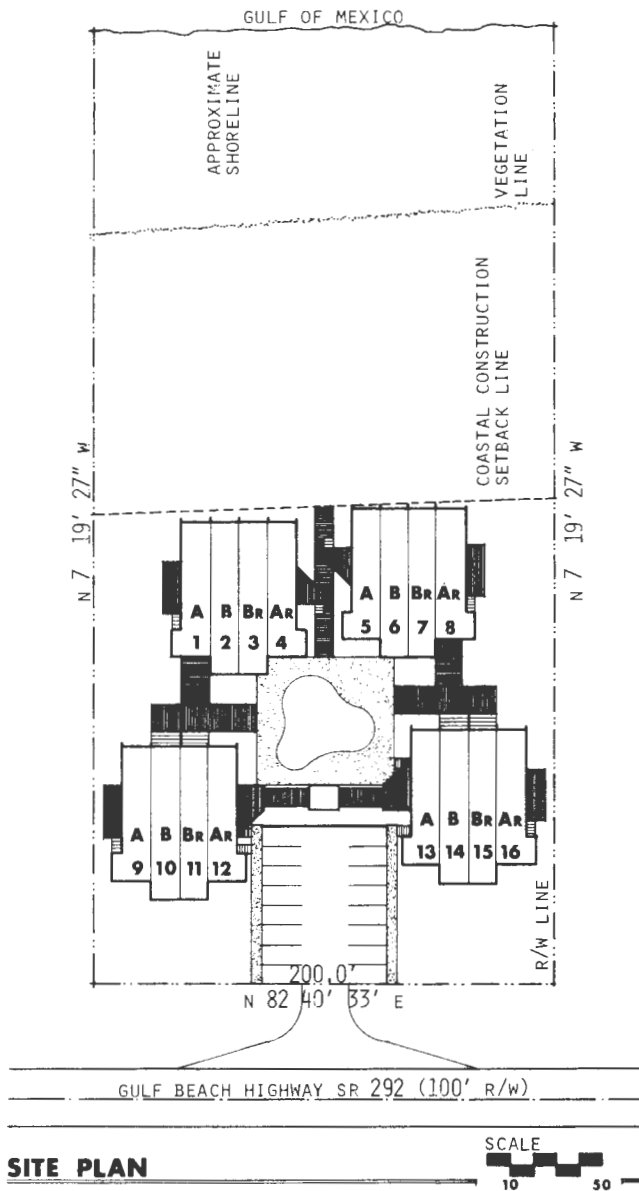

Figure 3.64

The buildings' exteriors are of cedar. The buildings were configured to reduce the impact of hurricane winds while maximizing views and privacy. At the same time, fenestration was placed to maximize natural ventilation. This and the use of insulated glass have reduced the need to use the units' air-conditioning.

A variety of forms and shapes provide visual interest and a variety of living spaces for the units' occupants, who use the units mostly as vacation homes. The units are situated around a central pool and landscaped area, which provides the occupants a well-defined community space.

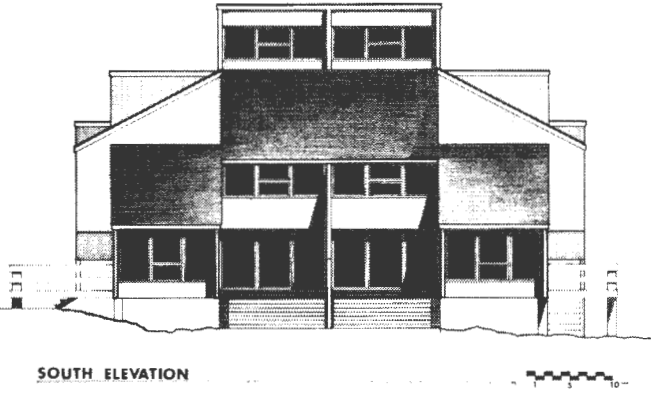

Figure 3.65

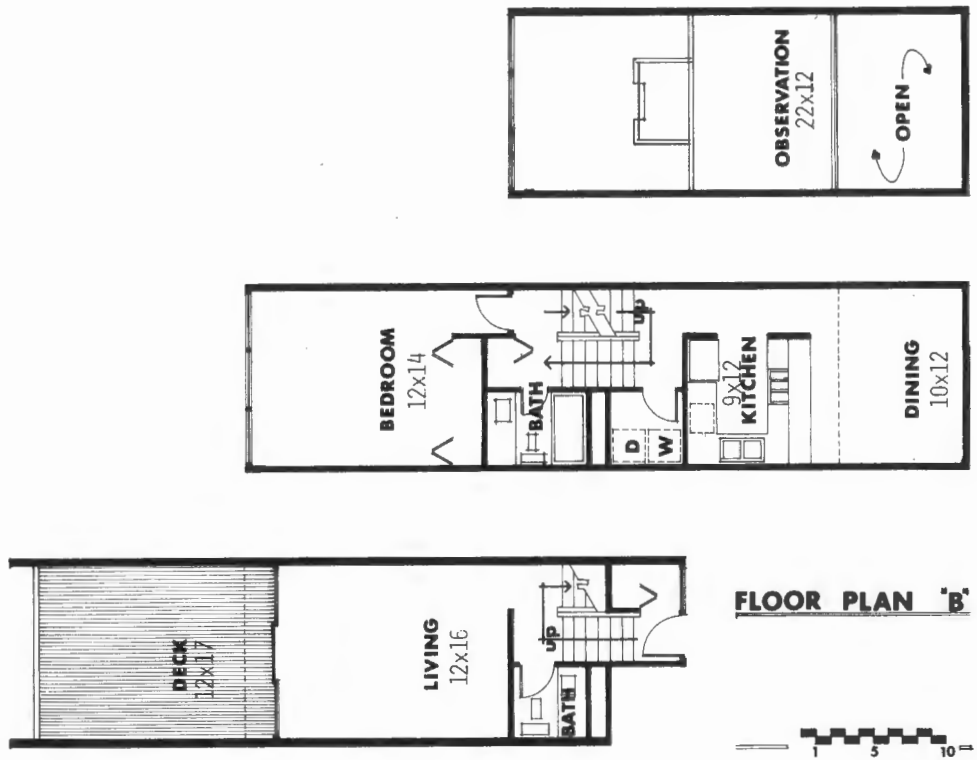

Figure 3.66

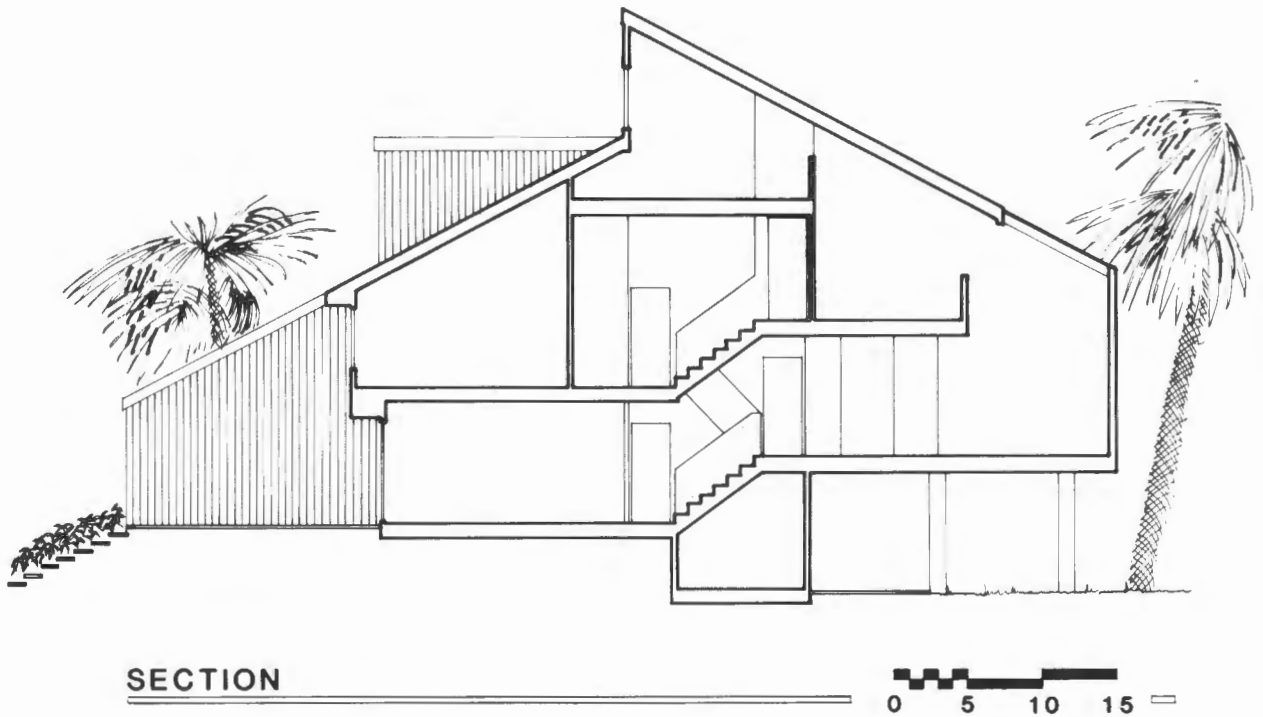

Figure 3.67

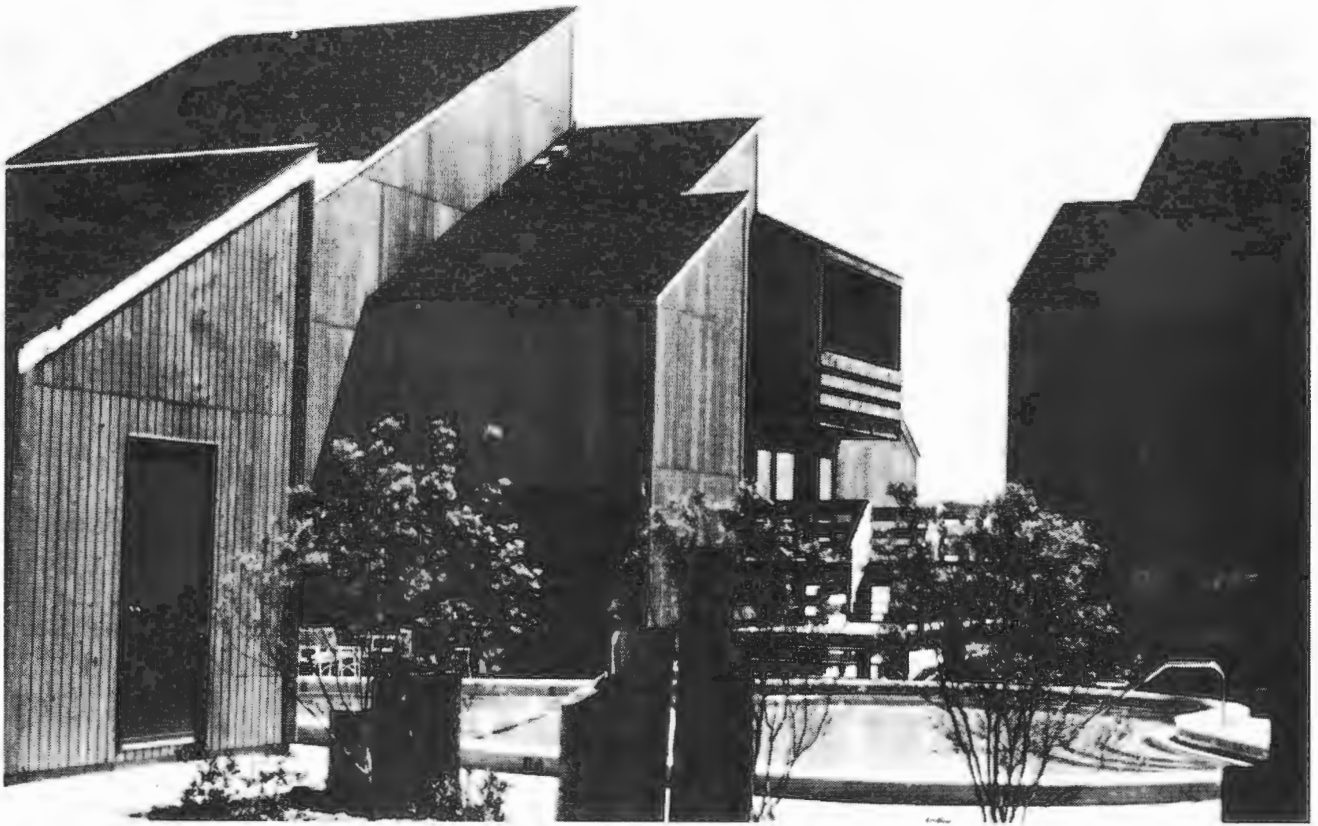

Figure 3.68



Figure 3.69



Figure 3.70

# DESIGN AND CONSTRUCTION GUIDELINES

---

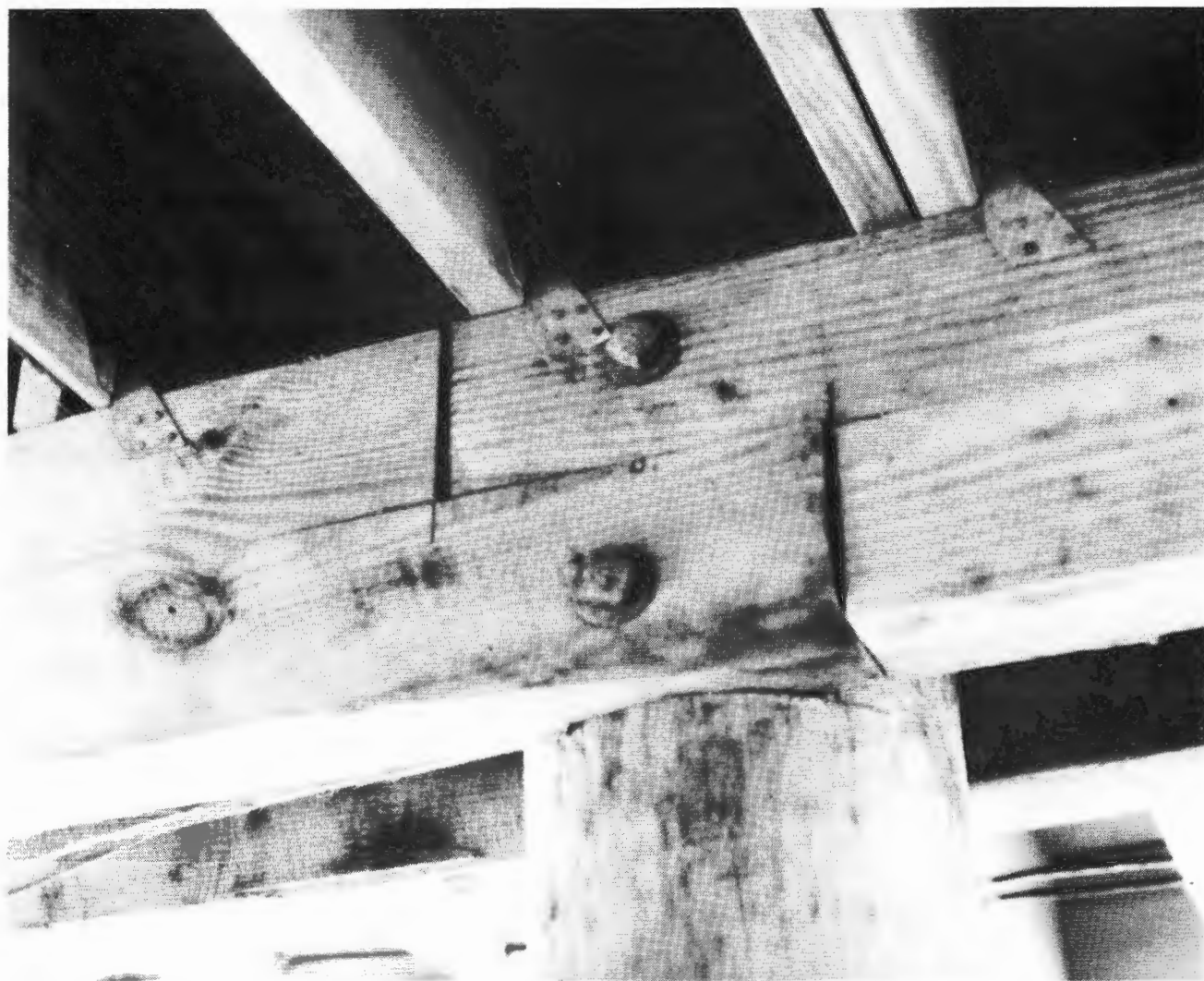

# Foundations

---

The common methods of elevating residential structures are earth fill, elevated foundations, shear walls, posts, piles, and piers. The selection of an elevation technique depends on a number of variables, including hydrologic factors, physical conditions at the site, and cost. The determination of the appropriate technique requires analysis of these factors in the context of federal, state, and local regulatory requirements. In some cases it can be advantageous to use a combination of elevation methods. For example, a building raised on fill at one end and piers or posts at the other could provide ground floor access at the end of the building away from the floodplain while minimizing obstruction of flood waters at the end nearer the stream channel.

The following discussion of the design and construction of elevated residential structures is based on accepted building practice. Generally, a conservative approach has been taken in order to ensure compliance with the building codes most widely used in the United States. In addition, the performance criteria presented later in this manual can be used to review a building's expected response to flooding. Analysis of flood-induced loads and soil conditions, as well as normal loads, stresses, and deflection of structural members, is required to ensure satisfactory building performance.

Note that foundations in V Zones should be designed in accordance with *Design and Construction Manual for Residential Buildings in Coastal High Hazard Areas*, cited in the Preface.



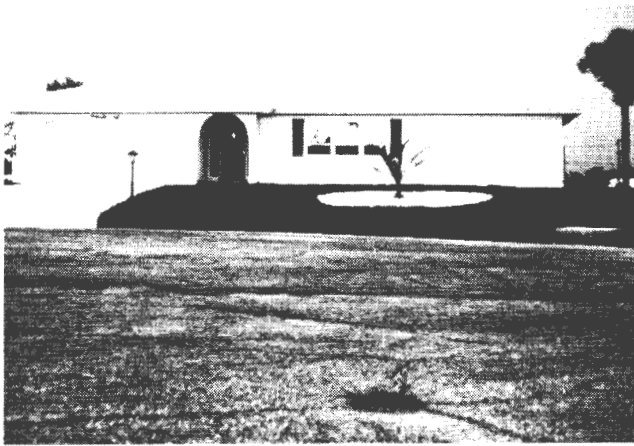

Figure 4.1. Elevation by Earth Fill

## FILL

At many A-Zone sites with low-velocity flooding it is feasible to elevate structures on earth fill (Figure 4.1). Earth fill is a widely used elevation technique that with proper construction practices and materials can be the most economical means of elevating a building two or three feet above grade or in some locations even higher. Fill should not be used in V Zones, where high-velocity flooding occurs, or at sites where fill would constrict the flow of flood waters and cause increased flooding heights or velocities.

The advantages of fill (as opposed to piles or similar elevated foundations) include its generally traditional appearance, ease of access to the lowest floor (i.e., no stairs are required), the ability at many sites to connect the filled area to higher ground for emergency evacuation in a flood, the safety of building elements from deterioration caused by exposure to flood waters, and the thermal insulation the earth provides the bottom of a house. In cold climates, furthermore, spring flood water under a house elevated on piles can freeze, with the danger of uplifting the structure.

A site's topography and soil conditions may preclude use of fill. Before fill is put in place existing vegetation and any unstable topsoil must be removed. The fill should then be placed in layers not exceeding 12 inches deep, with layer compacted with pneumatic or sheepsfoot rollers or vibrating compacting equipment. For most residential applications, compaction to 95 percent of the maximum density obtainable with the Standard Proctor Test Method issued by the American Society for Testing and Materials (ASTM Standard D-698) is usually sufficient.

Provision must be made for adequate surface drainage and erosion protection. Riprapping may be required for critical exposed slopes of a fill pad.

---

## ELEVATED FOUNDATIONS

In some situations site topography, poor soil conditions, aesthetics, or cost considerations may make it desirable to use an extended masonry or reinforced concrete foundation to elevate a house up to three or four feet above grade. Such a foundation can be bermed with earth fill to provide easy access and a conventional appearance.

Elevated foundations must be designed to withstand both hydrodynamic forces caused by velocity waters and hydrostatic forces caused by standing water. This may require added reinforcement in the walls. Where the foundation is not bermed with fill, a further design consideration would be the provision of sufficient openings in the foundation to allow the unimpeded flow of flood waters through the foundation. This can help minimize both hydrodynamic and hydrostatic forces without affecting the strength of the foundation if designed properly.

## SHEAR WALLS

Shear walls, although more commonly used for motels, apartments, and other more massive structures, can also be used to elevate smaller residential structures (Figure 4.2).

A shear wall acts as a deep beam in resisting forces in the plane of the wall. Structurally, the most critical design consideration is the low resistance of a shear wall to lateral forces. Shear walls should thus be used only in areas subject to low- to moderate-velocity flooding and should be placed parallel to the expected flow of flood waters. It is important that load and impact forces be determined for the entire range of flow directions. In addition, a shear wall's vulnerability to lateral forces makes it critical that connections between the wall and the foundation elements below grade be well designed.



Figure 4.2. Elevation by Shear Walls

## POSTS

Post foundations (Figures 4.3 and 4.4) use long, slender wood, concrete, or steel posts set in pre-dug holes. Posts can be round, square, or rectangular in section, though square and rectangular posts are easier to frame into than round ones. With steel posts, wide flange shapes or pipe or square tube sections are usually used.



Figure 4.3. Elevation by Posts



Figure 4.4. Elevation by Posts

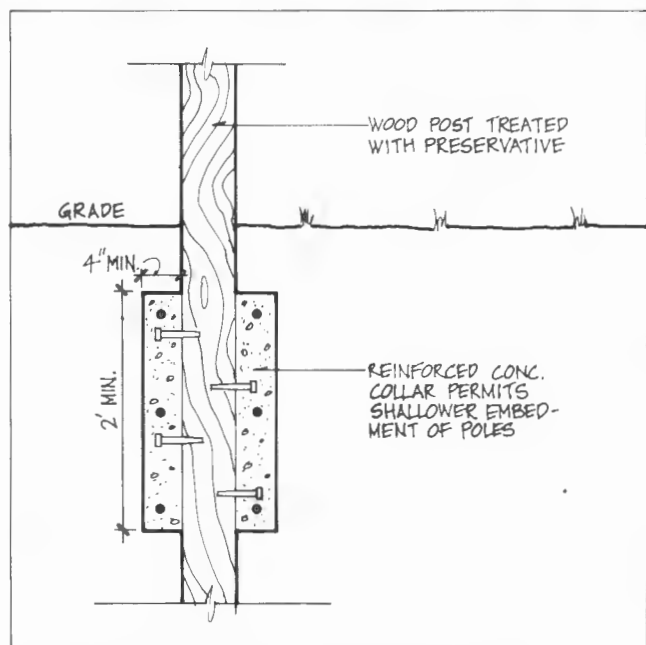

Figure 4.5. Reinforced Concrete Collar

Post foundation holes are dug by hand or machine. Posts longer than 16 feet generally require machine assistance for safe handling. Posts are generally less resistant to lateral forces from flood waters than piles or reinforced concrete masonry piers. Bearing capacity and stability of posts can be improved by pouring a concrete bearing pad at the bottom of the hole and/or pouring a concrete collar around the post after it has been partially backfilled (Figure 4.5).

### Post Embedment

The depth to which posts should be embedded depends on soil conditions, including the depth of the frost line; vertical loads; lateral loads from flood waters, debris impact, and wind forces; the anticipated erosion and uplift; and the spacing and size of the posts.

The following comments and sketches indicate embedment techniques for wood posts; steel and concrete posts' requirements are similar.

*Hole Depth and Post End Bearing.* Wood posts are generally embedded 4 to 8 feet. Hole excavations beyond 8 feet become uneconomical, so piles are used.

If design loads are small and the allowable soil bearing capacity is adequate, i.e., dense sand or medium-stiff clay, the post can be set on undisturbed earth at the bottom of the hole (Figure 4.6).

For larger loads and/or poorer soil conditions, a concrete pad should be poured into the bottom of the hole (Figure 4.7). The pad should be approximately as thick as half its diameter, with a minimum thickness of 8 inches.

If extremely poor soil conditions are encountered it may be necessary to use concrete backfilling or piers, as discussed below, or to drive a group of piles and cast a pile cap for each post to bear on, as shown in Figure 4.8, anchoring the posts securely to the caps. This can be more expensive than other foundation types.

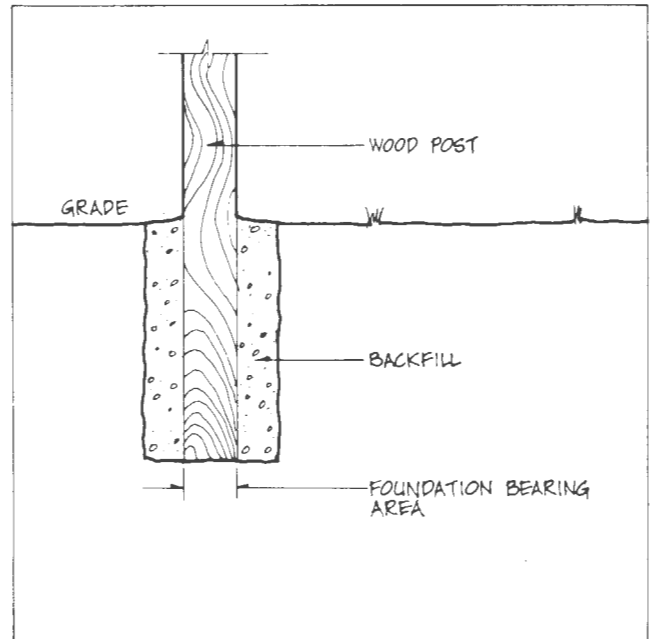

Figure 4.6. Earth Bearing

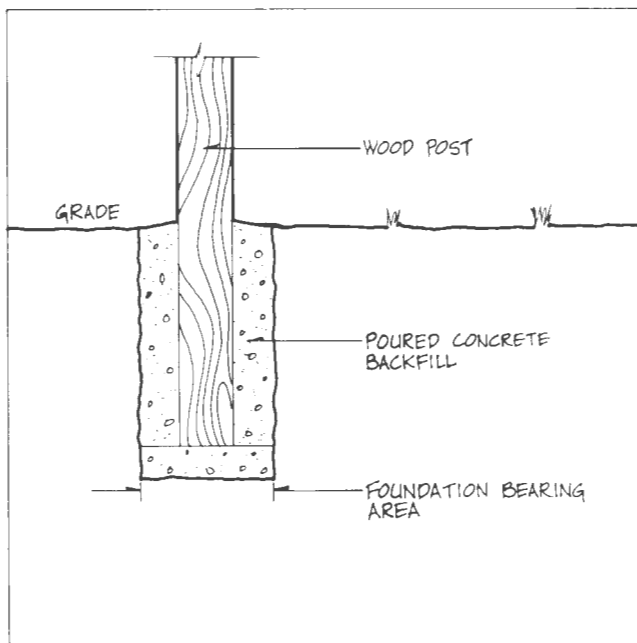

Figure 4.7. Post on Concrete Bearing Pad

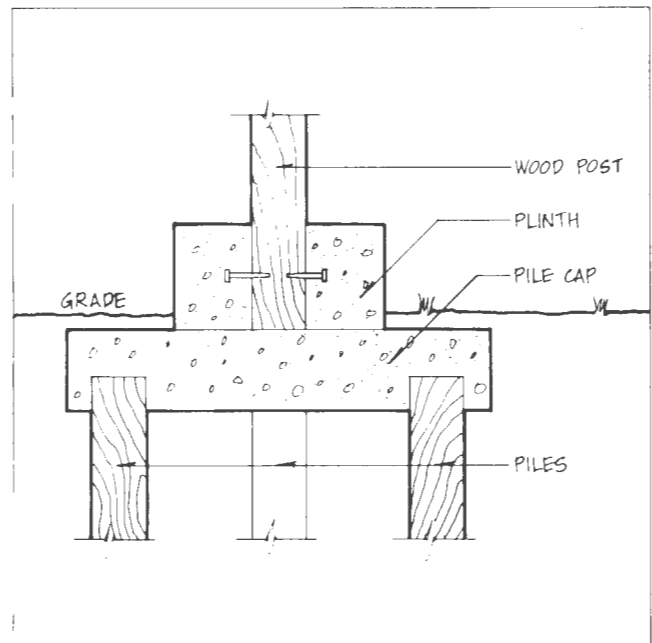

Figure 4.8. Post/Pile Foundation

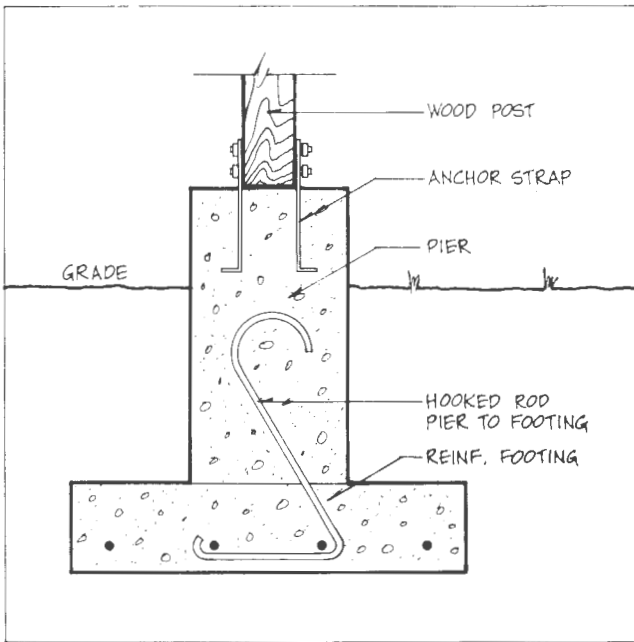

Figure 4.9. Post/Pier Foundation

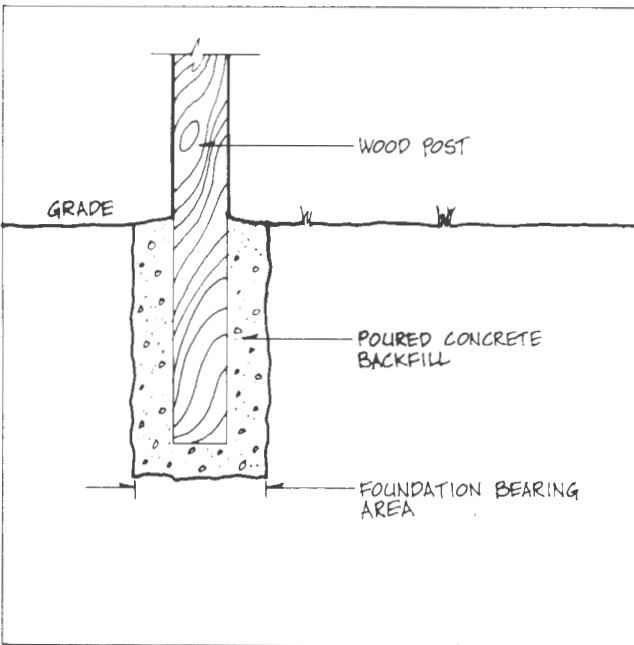

Figure 4.10. Concrete Backfill

Wood posts can also be supported entirely out of the ground on concrete piers (Figure 4.9). More thorough maintenance is possible with this approach, but additional bracing may be required for lateral stability.

*Hole Size.* In post construction the hole should be a minimum of 8 inches larger in diameter than the greatest dimension of a post section. This allows for alignment and backfilling.

*Backfilling.* Clean, well-compacted backfill is necessary to ensure a structure with good lateral stability and resistance against wind and water uplift. Common backfill materials are sand, gravel, crushed rock, pea gravel, soil cement, concrete, and earth.

Granular fills that provide good drainage are generally considered the best. Drainage around the posts at grade level should be positive to keep water from collecting and deteriorating the posts. Backfill materials should be mechanically tamped to adequately compact them. Wetting such backfill materials as earth or gravel will aid compaction.

Backfilling the hole with concrete rather than gravel or sand, as shown in Figure 4.10, adds stability to the structure and increases the bearing area. Shallower embedment may be possible with this method.

Soil cement is an economical alternative to concrete and attains strength nearly equal to it. Soil cement is made by mixing the earth removed from the dug hole with cement in a ratio of 1 part cement to 5 parts earth (plus water as directed by the manufacturer). To achieve the best results all organic matter should be removed from the earth, and it should be sifted to remove all particles larger than 1 inch.

## Anchorage

Lateral forces and flood forces are less likely to overturn or uplift posts if the posts are anchored to a foundation. Two ways to anchor posts are to embed them in concrete or to fasten them to metal straps, angles, plates, etc., that are themselves anchored in concrete footings, piers, or pile caps.

Figure 4.11 shows one method of anchoring wood posts in concrete. Large (5/8- to 3/4-inch in diameter) spikes or lag bolts are driven into the post around its base. The post is placed into the hole and secured to bracing restraints to prevent movement through the footing while the concrete sets.

The metal fastening method of anchorage can be used above or below ground. Figure 4.12 shows a square wood post lag bolted to a metal shoe that is anchored in a pier. In Figure 4.13, heavy gauge galvanized steel straps are used to anchor the wood post to a concrete pad.

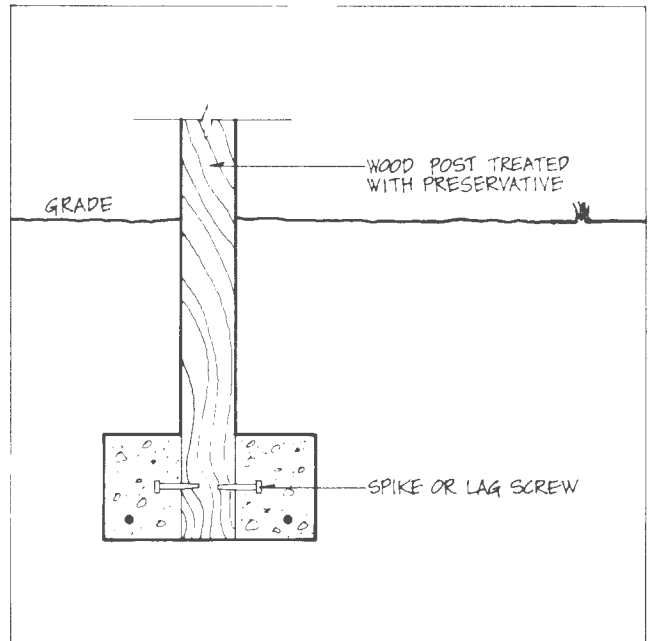

Figure 4.11. Spike Anchorage of Post

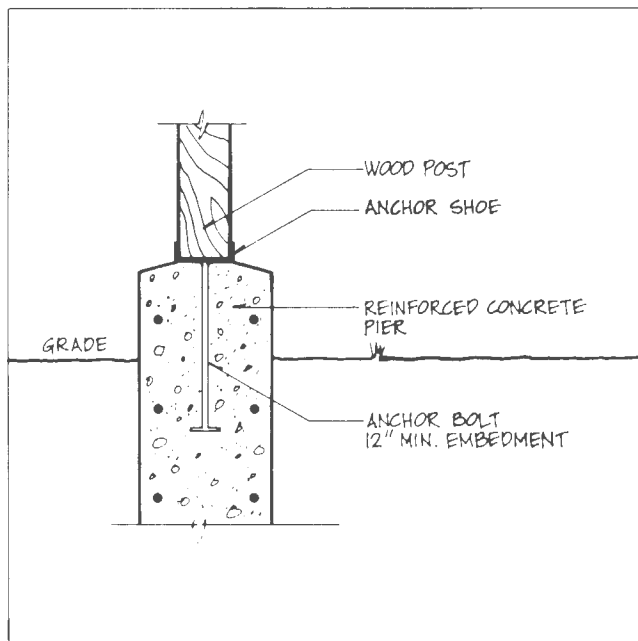

Figure 4.12. Metal Angle Anchorage Detail

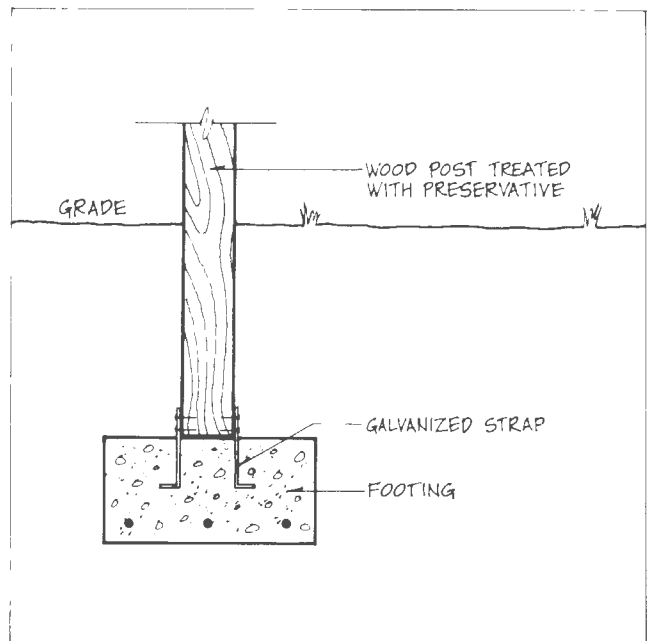

Figure 4.13. Galvanized Strap Anchorage Detail

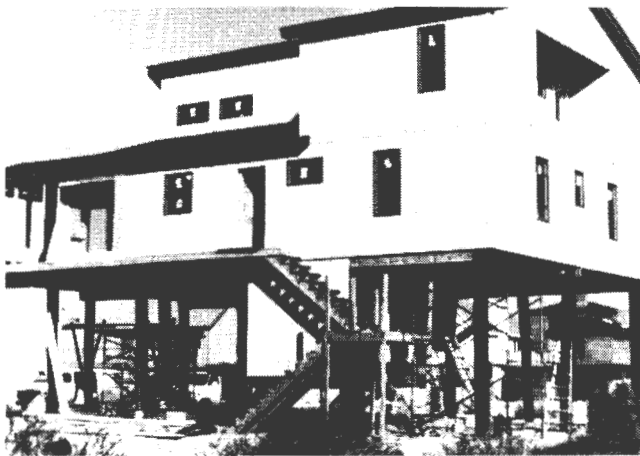

Figure 4.14. Pile Foundations

## PILES

Pile foundations (Figure 4.14) use long, slender wood, steel, or reinforced concrete piles that are driven or jettied into the ground. Vertical loads can be carried by driving piles to a load-bearing layer, such as rock (end-bearing piles), or by driving the piles deep enough into the earth to develop enough friction between the surface of the piles and the surrounding soil to carry the load (friction piles). Friction piles, which can also have an end-bearing component, are most often used for typical light residential loads.

Piles are structurally stronger than posts and are therefore more suitable for the extreme wind and water forces and erosion in coastal V Zones. Piles in V Zones should be designed in accordance with *Design and Construction Manual for Residential Buildings in Coastal High Hazard Areas*, cited in the Preface.

### Pile Materials

Piles can be concrete, steel, or wood. In coastal areas, where steel piles are not desirable because of corrosion problems, concrete piles can be particularly good when combined with precast concrete floor beams; such structural systems can be efficient, economical, and flood resistant. Concrete piles can be particularly suitable for buildings of more than two stories.

The vulnerabilities of different pile materials to environmental conditions are discussed in the materials section later in this manual.

Wood piles are probably the most widely used foundation for elevated residential structures. In some locations, square timbers are preferred over round piles because of cost, availability, and ease of framing and connecting the structural floor beams to the piles. The most popular suitable sizes (in inches) are 10 x 10 and 8 x 8 square roughsawn members.

---

Round timber piles are also frequently used. Generally, round piles are available in longer lengths than square timbers, and for lengths greater than about 25 feet round piles are frequently the only piles available. Round piles are often preferred because they can provide greater cross-sectional area, peripheral area, and stiffness than square sections, particularly the 8 x 8 timbers. A minimum tip diameter of about 8 inches, and a butt or top diameter (at the floor beam level) of about 11 inches or more are recommended for round piles.

### **Pile Embedment Methods**

A major consideration in the effectiveness of pile foundations is the method of inserting piles into the ground. This can determine the amount of the piles' load resistance. It is best to use a pile driver, which uses leads to hold the pile in position while a single- or double-acting hammer (delivering about 10,000 to 15,000 foot-pounds of energy) drives piles into the ground. A pile driver should be used for precast concrete piles and steel piles.

The pile driver method, while cost-effective for a development with a number of houses being constructed at one time, can be expensive for a single residence. An economical alternative, the drop hammer, consists of a heavy weight (several hundred pounds) that is raised by a cable attached to a power-driven winch. The weight is then dropped 5 to 15 feet onto the end of the pile. Drop hammers must be used with care because they can damage wood piles.

Disadvantages of pile driving include difficulties with alignment and with setting a driver up on uneven terrain. The advantage is that the driving operation forces soil outward from around the pile, compacting the soil and causing increased friction along the sides of the pile, which provides greater pile load resistance. A much less desirable but frequently used method of inserting piles into sandy coastal soil is "jetting." Jetting involves passing a high pressure stream of water through a pipe advanced alongside the pile. The water blows



---

a hole in the sand into which the pile is continuously pushed or dropped until the required depth is reached. Sand is then tamped into the cavity around the pile and the end of the pile pounded with the heaviest sledge hammer or other weight available. Unfortunately, jetting loosens not only the soil around the pile but also the soil below the tip. Therefore, only low end and side friction load capacity is attained, and the piles must be inserted deeper into the ground than if they were driven.

If the soil is sufficiently clayey or silty, a hole can be excavated by an auger or other means. The hole will stay open long enough to drop in a pile. Some sands have enough clay or silt to also permit the digging of a hole. Then sand or pea gravel can be poured and tamped into the cavity around the pile. Again, this does not provide as good load resistance as driving the pile into the ground, and longer piles are necessary. With short wood piles, some final driving with a sledge hammer can be helpful.

#### Soil Conditions and Embedment Depth

Local building codes often specify the required embedment depths of piles, e.g., to at least 6 feet below grade. Such codes often do not take into account the conditions at specific sites; a soils engineer should be consulted in doubtful situations. In addition, *Design and Construction Manual for Residential Buildings in Coastal High Hazard Areas*, cited in the Preface, provides useful information on this subject.



Figure 4.15. Pier Foundations

The required depth of pile embedment depends primarily on the number of piles used, the size and weight of the structure, and the type of soil at the building site. The pile depth is also influenced by the lateral forces from flooding and wind and debris impact, the manner in which the piles are inserted into the soil, and the need to allow for erosion of the soil that supports the piles.

In riverine environments the soil types and the anchorage provided by the frictional force of the soil against the sides of the pile vary widely. Sand is the dominant soil component in most coastal areas, but in some areas there may be

an underlying layer of several feet of clay. Generally, clay soils provide greater load-bearing capacity with less penetration than sandy soils.

Clay soils are also less susceptible to erosion. The depth of erosion of sandy soils caused by wave action is virtually impossible to predict. Piles supporting residential structures on sandy coastal shorelines should penetrate the ground deeply enough to provide resistance to wind and water loads even after extensive erosion has occurred.

Posts are often backfilled partly with concrete to improve their resistance to lateral forces. The same technique can be used with piles. After piles are driven, the area around each pile is dug out and a thick concrete collar is poured, extending several feet below grade. Such collars provide protection from minor erosion, add some deadweight to the structure, and increase piles' pull-out resistance.

## PIERS

Pier foundations (Figure 4.15) are suitable in areas away from a river or coastline where flood waters move with low velocity and erosion will be minimal.

Pier foundations use brick, concrete masonry blocks, or poured-in-place concrete to elevate structures. To resist horizontal wind and water forces, piers should rest on substantial spread footings or a grade beam, with reinforcing steel rods extending from these elements through the full height of the piers to resist tensile stresses.

### Pier Materials

The vulnerability of pier materials to environmental conditions is discussed in the materials section later in this manual.

### Brick and Concrete Masonry Piers

Brick piers and concrete masonry piers should be a minimum of 12" x 12" and reinforced with steel rods (Figures 4.16 and 4.17). Hollow concrete masonry units should be filled with concrete.

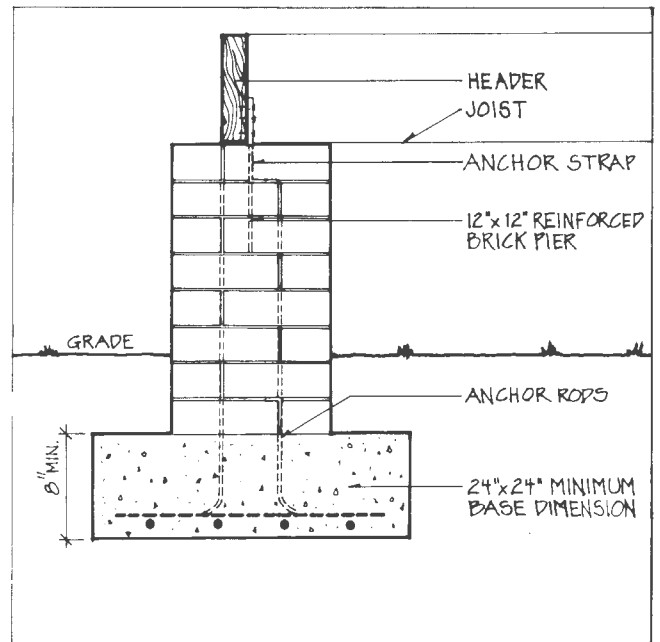

Figure 4.16. Reinforced Brick Pier

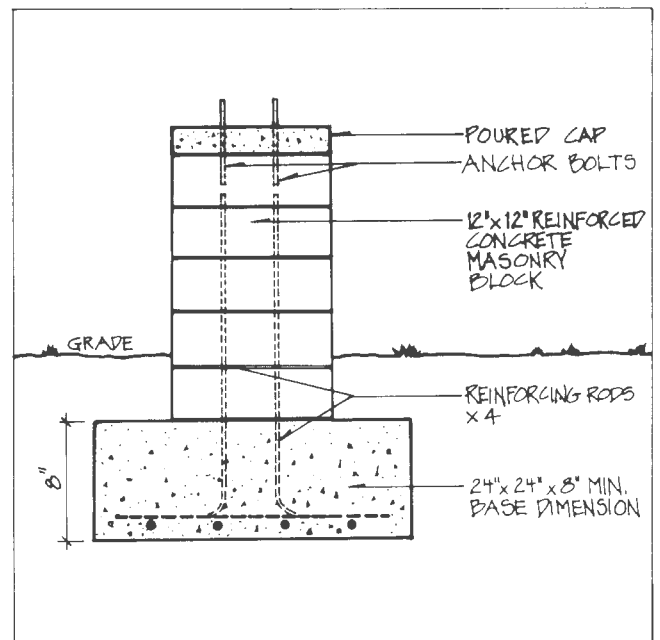

Figure 4.17. Reinforced Concrete Masonry Pier

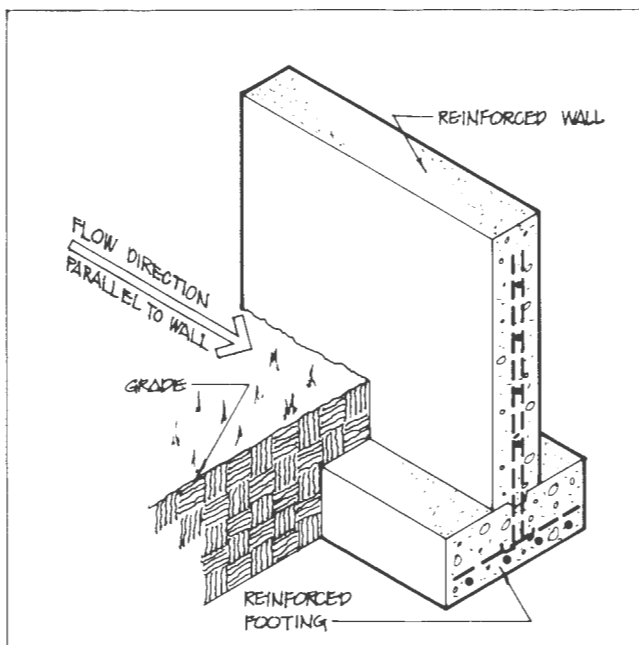

Figure 4.18. Wall Foundation

Reinforced brick piers can be used to elevate structures 1½ to 6 feet off the ground. Concrete masonry piers are effective for elevations of 1½ to 8 feet. In general, the height of reinforced concrete masonry piers should be limited to a maximum of ten times their least dimension. Square piers are preferable. If the piers are rectangular the longer dimension should not exceed the shorter dimension by more than 50 percent.

According to the National Concrete Masonry Association, the allowable working stresses for concrete masonry piers are the same as those for the design of concrete masonry walls. The pier masonry should be laid with type M or S mortar. The association also recommends that the spacing between piers supporting floor joists not exceed 8 feet in the direction perpendicular to the joists, nor 12 feet in the direction parallel to joists.

These minimum requirements apply whether the pier is free standing or laterally braced. In cases where exceptionally large loading conditions may exist, the pier cross-section should be increased and/or additional reinforcement added. A larger cross-section can be obtained by using piers several feet in length. The long dimension should be placed parallel to anticipated flood flow, as in Figure 4.18. In coastal areas, however, flood forces may come in at an angle, loading such a pier adversely, so alternatives should be considered.

## Poured-in-Place Concrete Piers

Poured-in-place concrete piers are essentially reinforced concrete columns. They are cast in forms set in machine- or hand-dug holes. The holes can be widened or belled at the base to form a footing integral with the pier, or, as shown in Figure 4.19, a separate footing can be poured. If soil conditions are appropriate the footing can be eliminated and loads left to end bearing and friction between the soil and pier (Figure 4.20). Poured-in-place piers of the latter type can be particularly effective for larger homes or developments of single-family homes and townhouses.

Poured-in-place concrete piers can be used to elevate a structure 1½ to 12 feet or more. The dimensions, reinforcement, and spacing of concrete piers depend on the type of building framing used and on building and environmental loads; structural analysis is required.

### Pier Footings

Pier footing sizes are a direct function of soil bearing capacity and loading, and can be computed on the basis of local codes. Depth of pier footings depends on local frost penetration levels and expected flooding, wind, and erosion levels. Footings in areas with soils of high volume change potential can be unstable, and should be designed with the guidance of a soils engineer.

### BRACING ELEVATED FOUNDATIONS

Elevated foundation elements must be braced when analysis indicates that their size, number, spacing, and embedment will not be sufficient to resist lateral forces. Even in areas where low-velocity flooding is anticipated, bracing can provide added assurance that the structure will withstand the impact of floating debris or greater-than-expected flood or storm forces. Although bracing placed underneath a structure may be struck by floating debris, the effects of this on a structure's survivability are generally outweighed by bracing's beneficial effects.

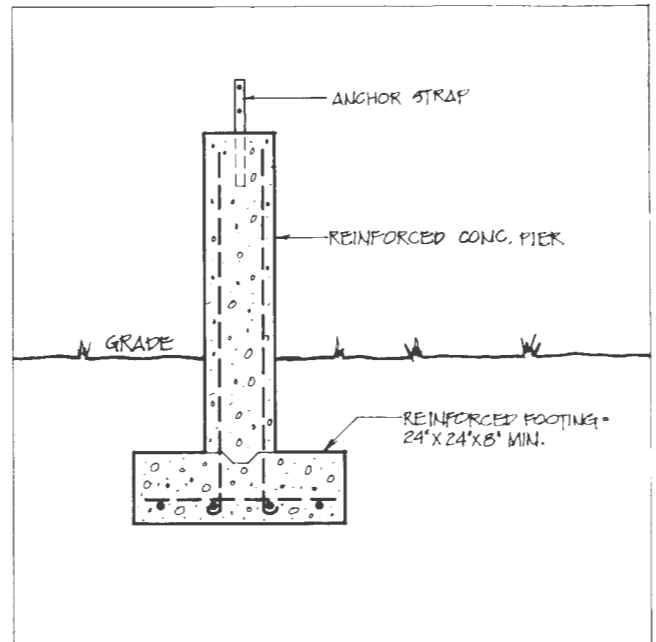

Figure 4.19. Reinforced Concrete Pier

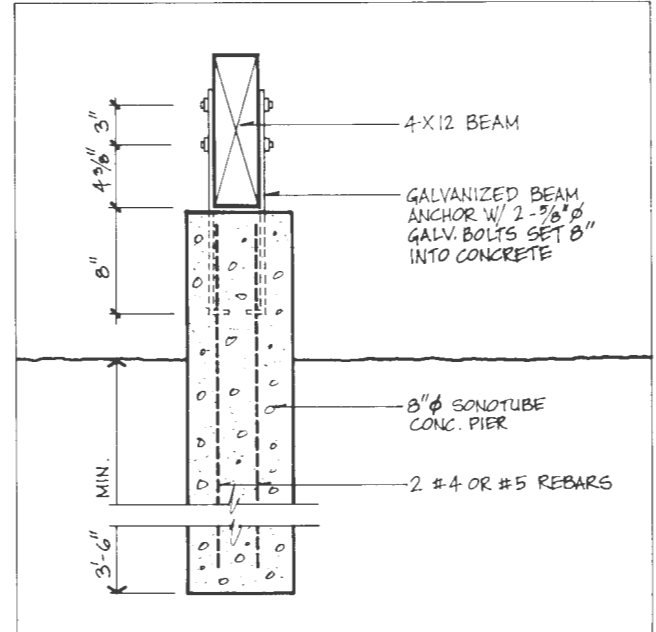

Figure 4.20. Drilled Pier Foundation

## Knee Braces and Diagonal Bracing

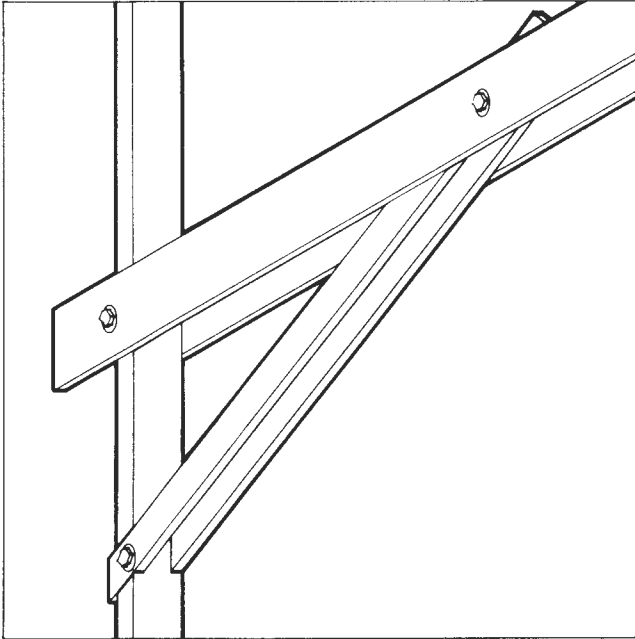

Figure 4.21. Knee Brace

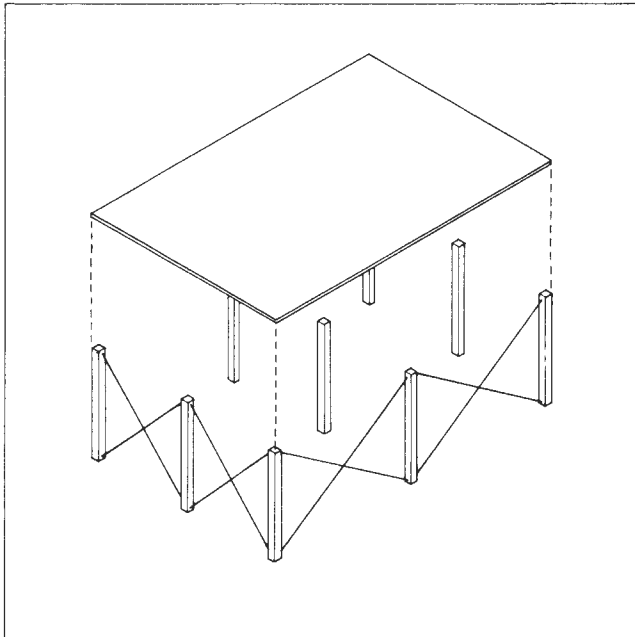

Figure 4.22. Diagonal Bracing

Knee braces (Figure 4.21) and diagonal bracing can be effective in providing lateral strength. Lumber more than 2 inches thick is usually recommended. Bolts are preferred over nails for connecting bracing, because of bolts' greater resistance to pullout forces. Knee bracing is usually bolted between the floor joist and post or pile.

Diagonal bracing (Figures 4.22 and 4.23) is bolted at the base of one post or pile and fastened in a like manner to the adjacent post or pile just below the floor beams. Although diagonal bracing is more likely than knee bracing to be struck by floating debris, this is generally outweighed by the greater lateral stability with diagonal bracing, especially in higher elevated structures. Steel rods can sometimes be used to diagonally brace wood posts or piles. The rods are fitted through drilled holes flooded with wood preservative and fastened with nuts and cast beveled washers. Welded connections or drill holes can be used to provide rod bracing in steel post or pile foundations. Such rods are usually 5/8 to 3/4 inches in diameter. Steel diagonal ties, while effective, require considerably more monitoring and maintenance than wood because of steel's susceptibility to corrosion.

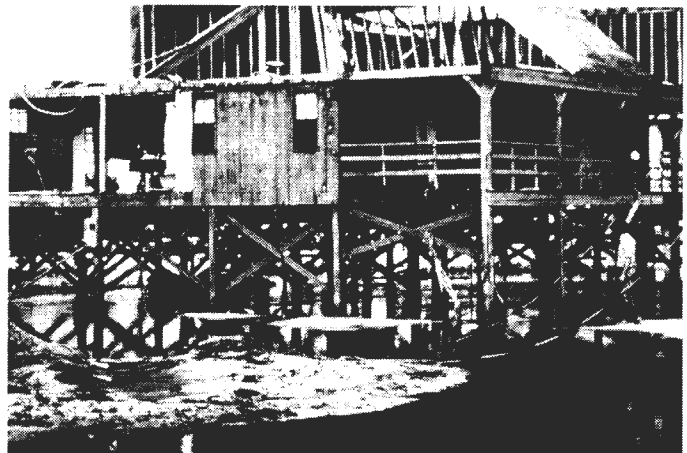

Figure 4.23. Diagonal Bracing

## Shear Walls and Floor Diaphragms

In areas with low- to moderate-velocity flooding, shear walls placed parallel to the flow of flood waters and firmly attached to piles or posts can help brace them (Figure 4.24).

With wood shear walls, the plywood sizes, the strength of wall edges, and the walls' anchorage are all important to effective bracing.

A shear wall can be used in conjunction with a floor diaphragm (Figure 4.25) to transfer horizontal forces or reduce embedment depth when, for example, solid rock is reached when digging foundation holes. A floor diaphragm can be used with either pole frame or platform construction. Floor diaphragms usually call for 1/2- or 3/4-inch plywood.

The severe lateral forces encountered in coastal V Zones can require the use of trusses, grade beams, or slabs to provide adequate support. These are discussed in *Design and Construction Manual for Residential Buildings in Coastal High Hazard Areas*, cited in the Preface.

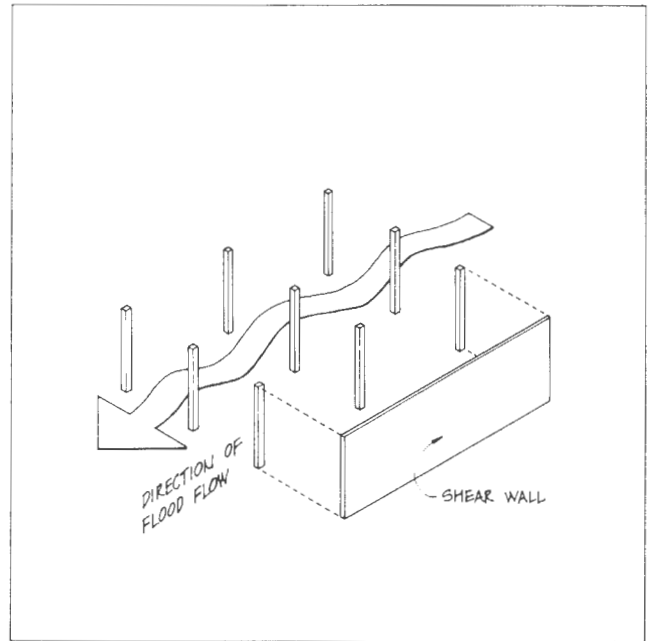

Figure 4.24. Shear Wall Bracing

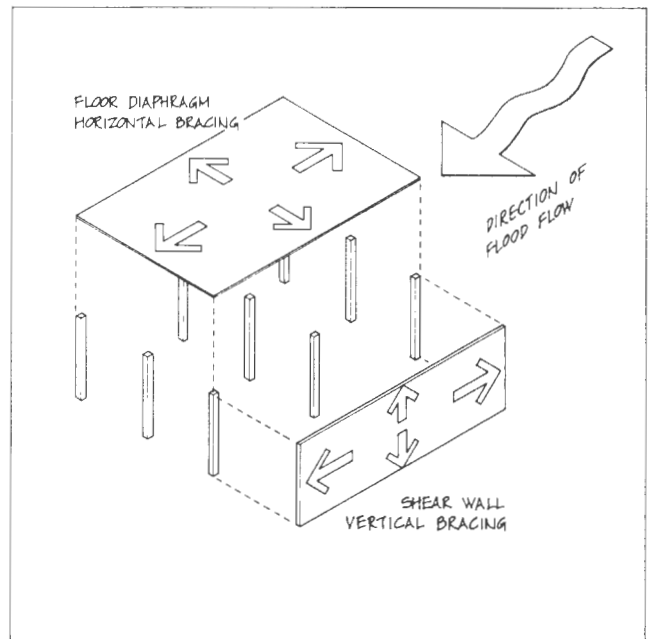

Figure 4.25. Floor Diaphragm Bracing

# Framing Construction and Connections

---

The framing construction and framing connections in an elevated home can be critical to its ability to withstand flood forces with minimal damage. Construction in most non-flood areas must support loads imposed by the weight of the building materials (dead load), weight of people and objects (live load), and modest loads imposed by wind. Under normal conditions and with typical methods of framing construction and framing attachment, these loads act downward through gravity to hold the building's structure together.

However, these loads represent only a portion of the loads imposed on any structural system in flood-prone areas, particularly in coastal V Zones. Additional forces can be applied to these structures by floating debris, velocity flooding, extreme winds, and wave action. These buildings' structural system must be capable of withstanding these loads and still support the structure and its contents.

Coastal V Zones are virtually certain to be subjected to the extremes of these forces, and homes there should be designed in accordance with *Design and Construction Manual for Residential Buildings in Coastal High Hazard Areas*, cited in the Preface.

Even in riverine and coastal A Zones, however, prudence suggests that homes be built with a margin of safety beyond that needed in non-flood areas. Consideration should also be given to the possibility that flood forces may be greater than those anticipated on the basis of past floods or hydrologic analyses. Coastal areas pose the additional danger that shifting dunes or other storm-induced topographic changes can transform relatively safe A Zones into V Zones, which experience the full force of ocean storms.

Measures to provide a home with an extra margin of safety to resist these forces are not expensive, e.g., having floor joists 12 inches on center instead of 16 inches on center, or using deformed shank or annular ring nails because of their greater holding ability. Nor are the needed craftsmanship and anchorage methods uncommon to the carpentry trade. Simple nailing, for example, especially end or

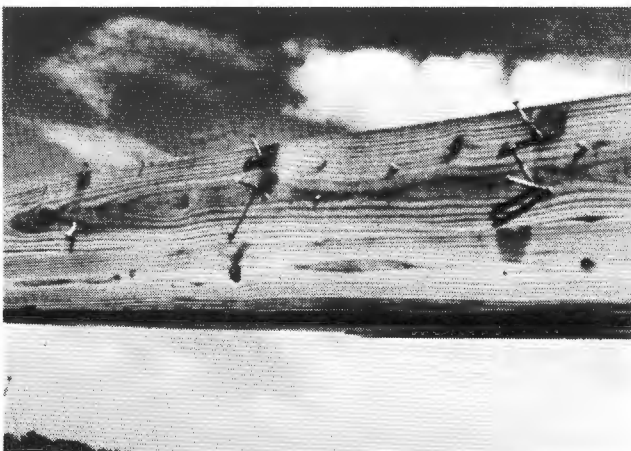

Figure 4.26. Toe Nailing Provides Limited Pull-Out Resistance

toe nailing, provides little resistance to flood forces, partially because of the tendency to split the wood in the toe-nailed member (Figure 4.26). Bolts, lag bolts, or nails in metal anchors at right angles to the direction of force (Figure 4.27) are well-known methods of increasing structural strength.

The following paragraphs discuss prudent framing construction and connections practice from the bottom up, starting with the foundation-to-floor-beam connections and floor beam construction and ending with wall-to-roof connections.

## FOUNDATION-TO-FLOOR-BEAM CONNECTIONS

### Post and Pile Foundations

The connection of a post or pile foundation to the framing system of a structure is influenced by the method of framing used and the cross-sectional shape of the post or pile.

*Framing Methods.* Two different methods for framing into post or pile foundations are in common use today: platform construction and pole frame construction.

Platform construction entails simply cutting posts or piles off at the desired elevation and framing them with beams to support floor joists and deck. The platform thus formed serves as the first habitable floor and construction platform for any type of conventional framing structure desired (Figure 4.28).

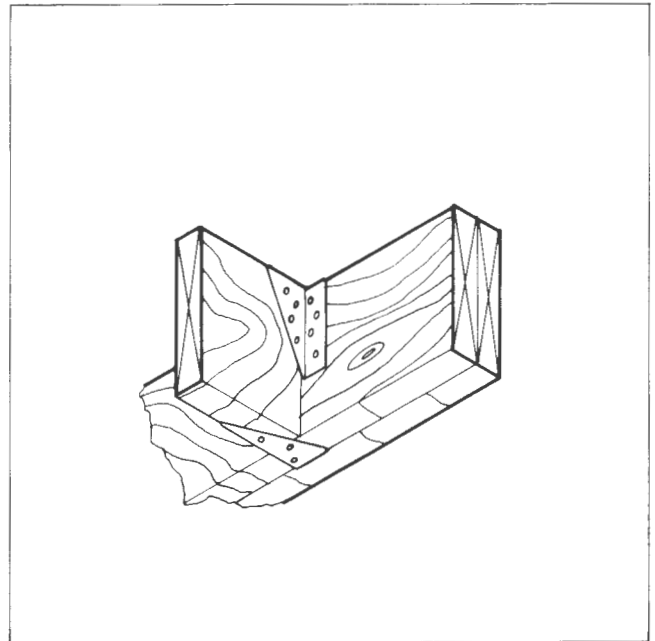

Figure 4.27. Metal Framing Anchors

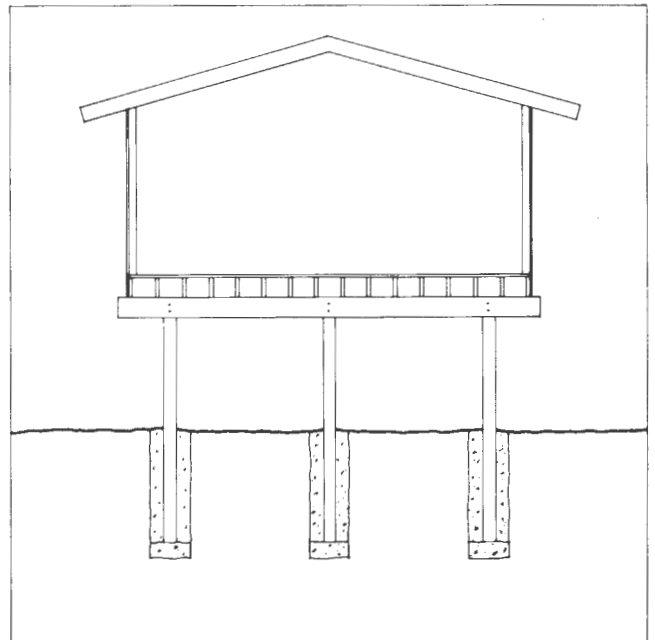

Figure 4.28. Platform Construction



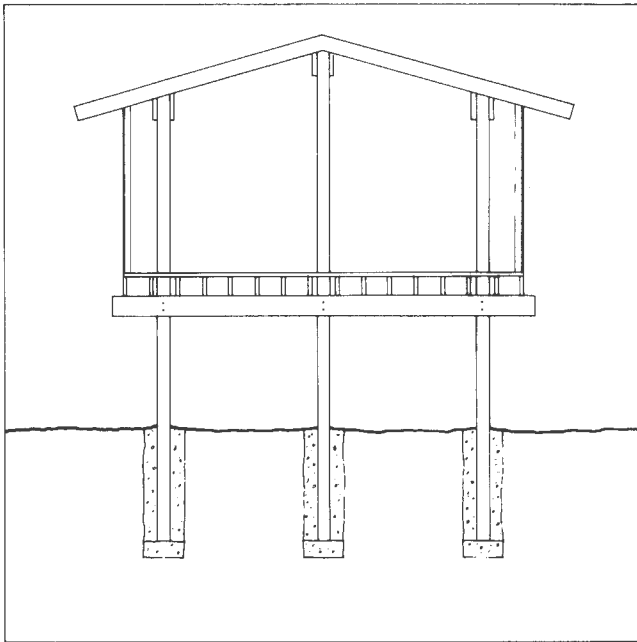

Figure 4.29. Pole Frame Construction

In what is termed pole frame construction, the posts or piles are extended up to or through the roof, with beams framing around them as supports for floor joists and roof rafters (Figure 4.29). This method securely ties the entire structure together and is excellent for sites where lateral forces may be strong.

A basic problem with piles is their alignment. Posts can be plumbed and aligned easily before they are backfilled, but piles must be jacked and pulled into position. This can be more of a problem with pole framing than platform construction. A solution is to locate piles either on the interior or exterior of a structure, not in the walls. Then, as shown in Figure 4.30, allowance can be made for alignment variations.

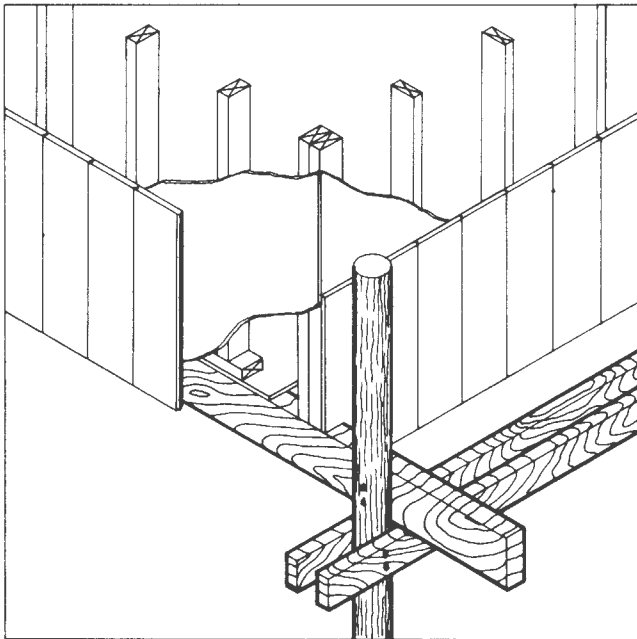

Figure 4.30. Exterior Pole Framing

*Cross-Sectional Shape.* Square posts or piles usually require only conventional framing techniques. With round posts or piles, however, the framing is somewhat more complicated, and it is generally best to frame the posts with a pair of beams, girders, or rafters—one on each side.

The roundness of wood posts is not a problem when using bolted or spiked connections as shown in Figure 4.31. The framing is then the same as for any other timber member.

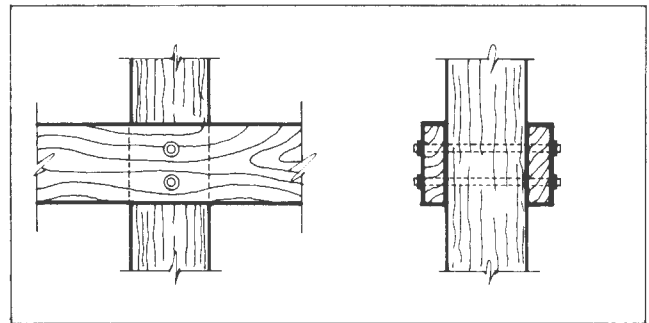

Figure 4.31. Bolted Connection to Round Pole

Another connection method is to eliminate the curve of the post or pile by dapping and then connecting with bolts, gusset plates, or other devices. As Figures 4.32 and 4.33 show, a dapped post will form seats that assist the beams in carrying vertical loads. Posts that are small in section, however, should not be dapped or they will be weakened. Generally, there should be a thickness of post or pile for the bolts to bear on equal to the total thickness of the floor beam. Two bolts should be used to connect beams to each post or pile.

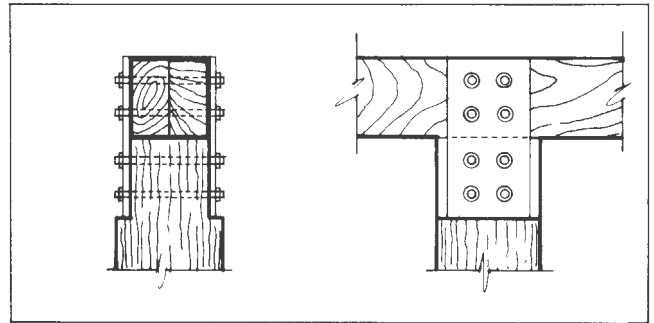

Figure 4.32. Dapped Gusset Plate Connection

Spike grid connections (Figure 4.34), standard in bridge and warehouse construction, are less common in residential practice. A single curved grid inserted between the post or pile and the beam substantially increases the strength of the bolted connection. With the curved side of the grid against the pole and over predrilled holes, a high-strength threaded rod is used to squeeze the two wood surfaces together, forcing the tooth of the spike grid into the grain of both members. The high-strength rod is then replaced with a conventional bolt of the proper size. A flat spiked grid is used to connect two flat surfaces, and a double curved spiked grid to connect two rounded surfaces.

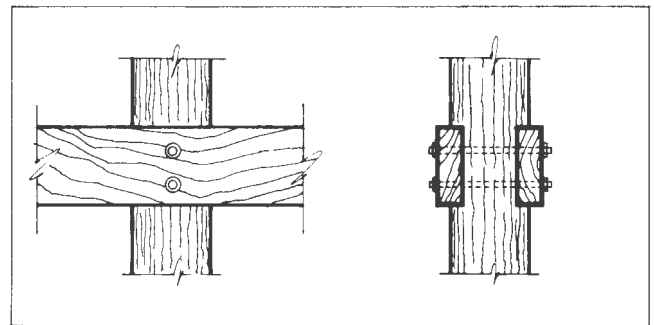

Figure 4.33. Dapped Pole Connection

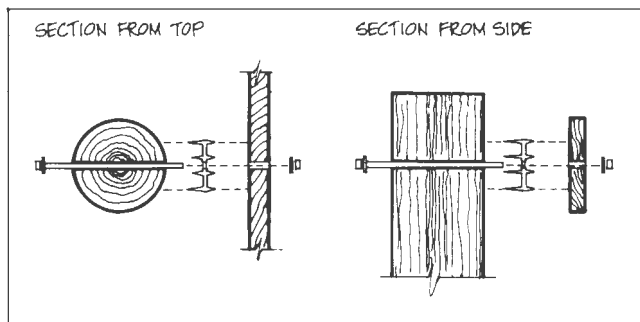

Figure 4.34. Spiked Grid

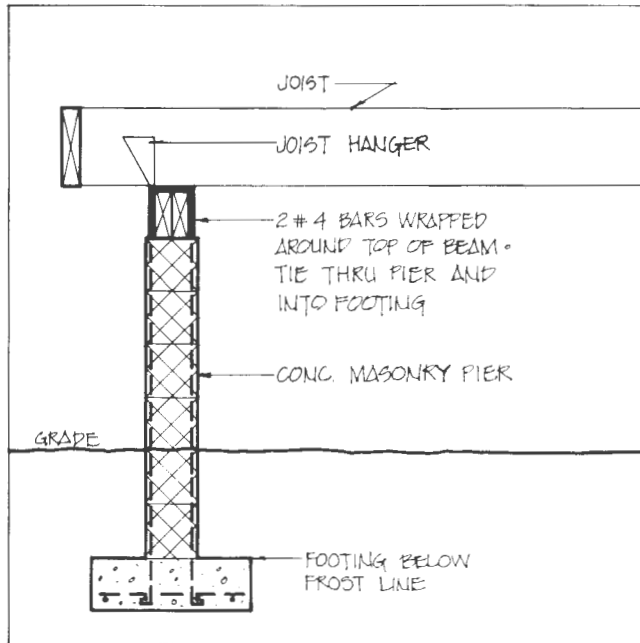

Figure 4.35. Concrete Masonry Unit Pier

## Pier Foundations

Pier foundations are generally used for platform framing construction rather than pole framing construction.

Piers can be connected to floor beams in several ways. A pier's reinforcing steel rods can be extended from the pier and bent over or into the floor beam (Figure 4.35). A metal strap well-anchored in the pier can be bolted through the beam (Figure 4.36). Or (Figure 4.37) steel anchor bolts can be embedded in the pier and bolted through the beams with nuts and large-diameter washers.

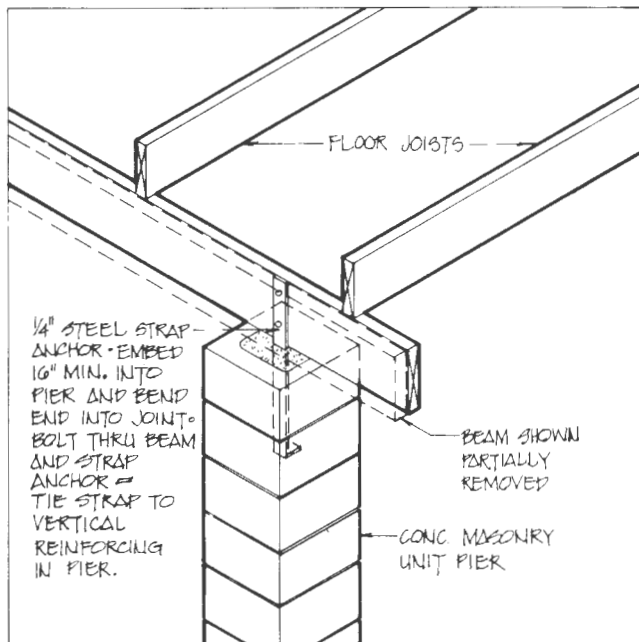

Figure 4.36. Masonry Pier—Strap Anchor

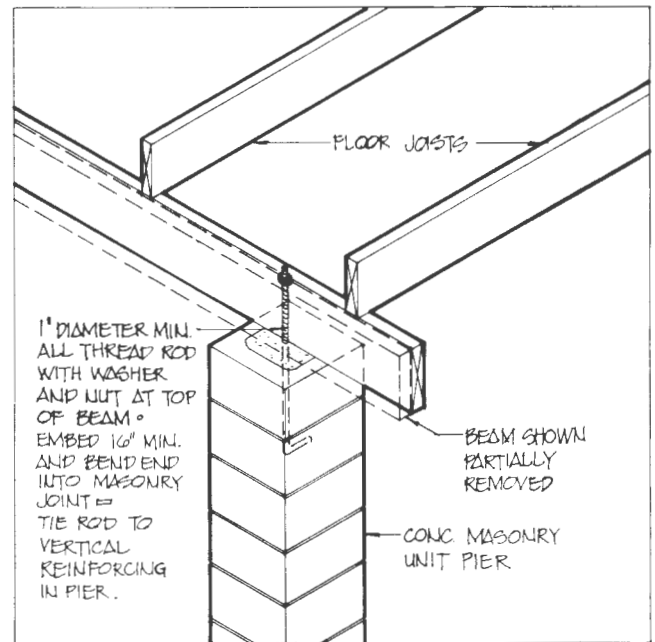

Figure 4.37. Masonry Pier—Bolt Through Beam

---

The bolts should be at least 1 inch in diameter and embedded at least 12 inches in concrete piers and 16 inches in masonry piers. If two floor beams abut on a pier, each must be anchored separately (Figure 4.38).

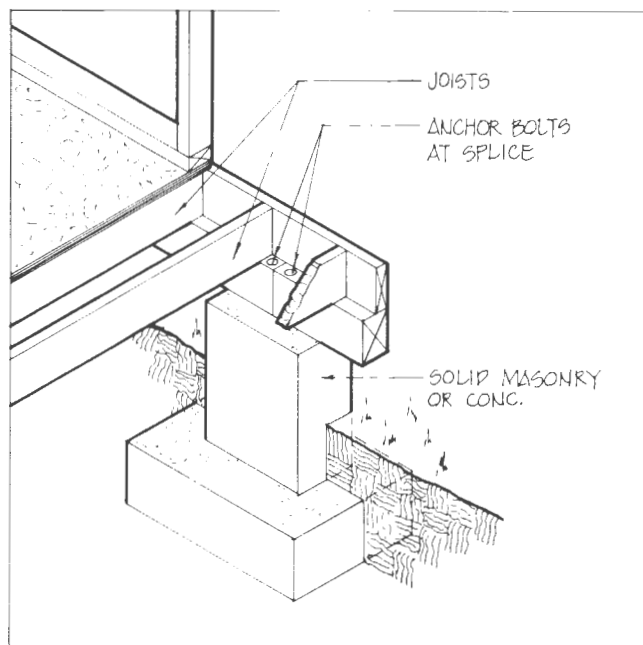

Figure 4.38. Beam Splice on Pier

## FLOOR BEAMS

The floor beams attached to foundation elements in turn carry the floor joists and subflooring. Since floor beams that are as long as the width or length of residential structures are often difficult to find and hard to handle, it is common to use splices. Splices may occur in several places and need not always be located directly over supports.

Floor beams are often 4 x 10's or up to 6 x 12's, but they may be built up using standard framing lumber, such as two, three, or four 2 x 10's or 2 x 12's, spiked or bolted together. Where beams are built up using a good grade of lumber for the laminated members, the strength of the built-up beam can equal that of a solid member. All members of the built-up beam should be continuous between supports, because splices materially reduce strength. Built-up members should include only one splice at any one location. The ends and tops of built-up members should not be directly exposed to the weather.

The primary floor beams spanning between supports should span in the direction parallel to the flow of potential floodwater. This orientation allows the first transverse member perpendicular to flow to be the floor joist. Thus, in the case of an extreme flood the beams would not be subjected to the full force of floodwater along their more exposed surfaces. This also reduces the potential for floating debris to damage the structure, and places the lowest obstacle to flow above the floor beam.

## CANTILEVERS

A cantilever is a projecting beam that extends beyond its support. The beam must be continuous (not spliced) over the last support prior to the cantilevered section, and depends on the vertical load applied for counteracting reactions (Figure 4.39). The practical limit recommended for a cantilever is normally one-third the length of the beam span prior to the cantilever.

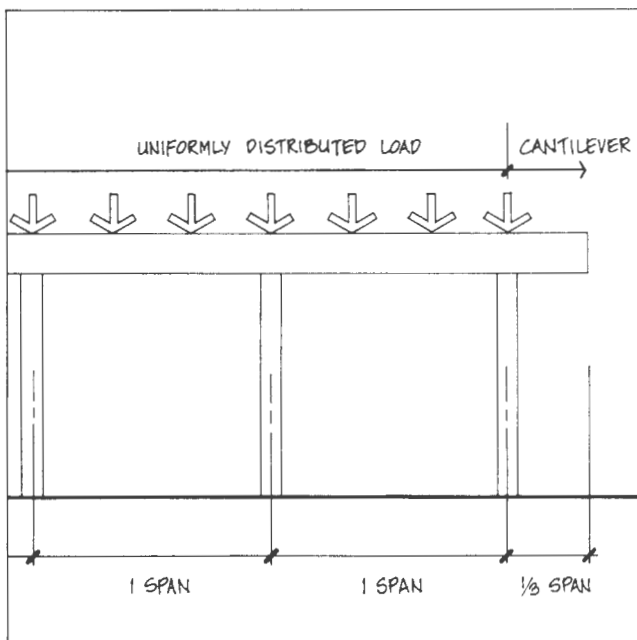

Figure 4.39. Floor Beam with Cantilever Overhang

The advantage of this method is that it can reduce the number of piles, poles, or piers required for a given area, as illustrated in Figure 4.40. Reducing the number of piles can result in potentially lower cost and fewer obstructions to the flow of flood-water and debris. Residences supported in this manner have the additional advantage of having the first row of piles set back, reducing the visual impact of elevating the structure. A cantilever design may use longer spans for the main floor beam and thus may require larger beams.

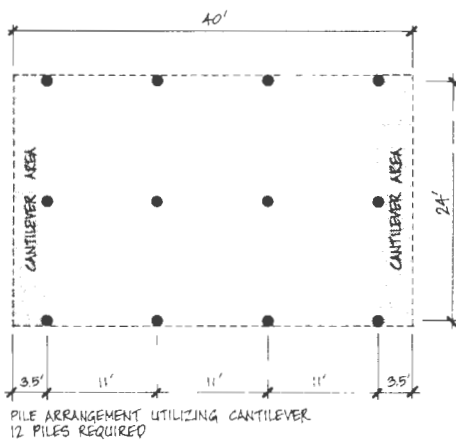
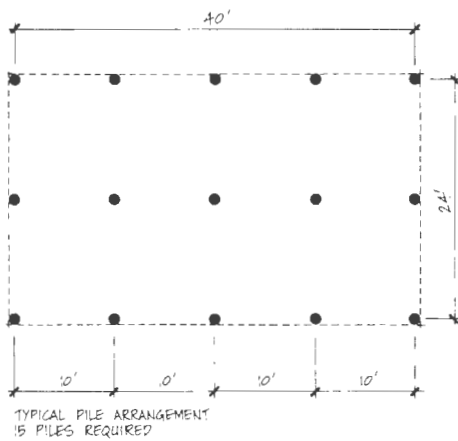

Figure 4.40. Cantilever Used to Reduce Number of Foundation Elements

## CONCRETE FLOORING SYSTEMS

Recently developed flooring systems using precast, prestressed concrete for floor beams, joists, and/or subflooring can often be useful in elevated structures. Construction and connection techniques for these systems are beyond the scope of this manual.

## FLOOR-BEAM-TO-FLOOR-JOIST CONNECTIONS

A positive connection is also required beneath the first floor level between the floor joists and floor beams (Figure 4.41). Metal connectors now available provide strong positive connection (Figure 4.42). Metal straps can also be used provided proper nailing is done and a sufficient number of straps is installed. At the minimum, every other joist and wall stud should be anchored with a strap, and even more for more severe loads (Figure 4.43). A good wood connector has also been developed. The capacity of these connections depends directly on the number of nails and their individual capacity to resist loads transverse to their axis. Pullout resistance along the axis is not used; rather, the nails are placed at right angles (perpendicular) to the loads being transferred between the wood members. The number of nails counted in figuring the total connection capacity of a given joint is the lower number that exists on either side of the joint. For example, in the connection of a floor beam to a floor joist, if five nails are in the beam and four are in the joist, the capacity of the connection is limited by the four nails on the joist.

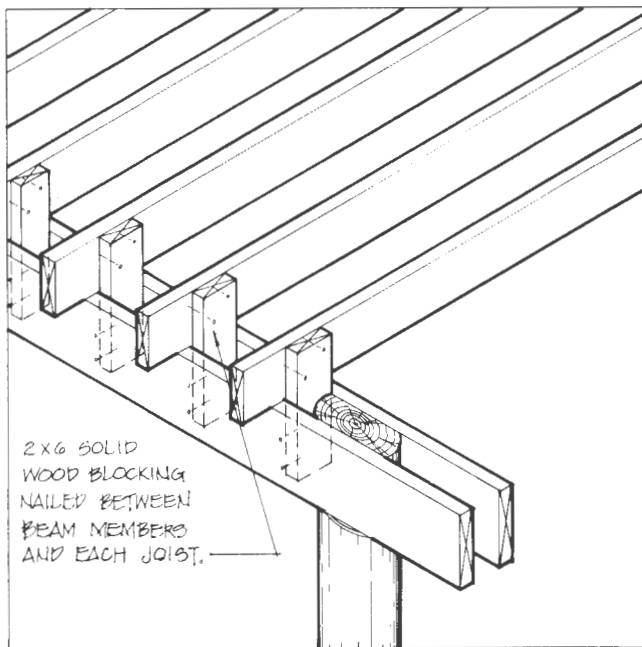

Figure 4.41. Wood Joist Anchors

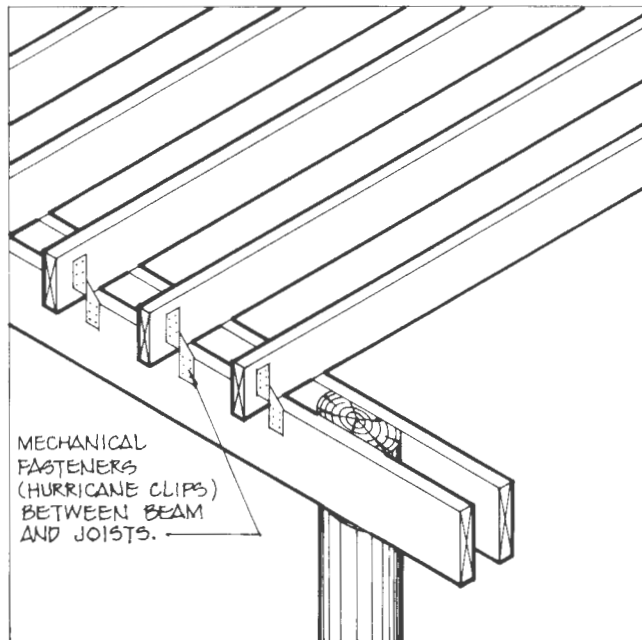

Figure 4.42. Metal Hurricane Clips

## FLOOR JOISTS

Cross-bridging of all floor joists is recommended to stiffen the floor system. The elevation makes the floors (particularly the first floor) more accessible to uplift wind forces, as well as to the forces of moving water and floating debris. Effective cross-bridging requires:

- nominal 1 x 3's 8 feet on center maximum
- solid bridging same depth as joist 8 feet on center maximum.

## SUBFLOORING

Two methods are commonly used for subfloor construction: nominal 1 x 4 or 1 x 6 boards placed diagonally over the floor joists (either tongue-and-groove or square-edge with expansion space between boards) and plywood subflooring used to create a floor diaphragm. When a plywood subfloor is planned, guidelines for thickness and methods of attachment in relation to joist spacing can be obtained from the *Plywood Construction Guide* published annually by the American Plywood Association. A well-constructed, firmly attached subfloor can be an important asset in resisting lateral forces.

Subflooring is typically nailed directly to the floor joists. Nailing with annular ring nails or deformed shank nails is recommended. These nails provide extra strength against pulling out when the floor system is exposed to loads other than gravity.

A system of nailing and adhesive application of plywood with tongue-and-groove joints along the long edges of the sheet avoids the need for blocking along these edges. This produces a more level floor and offers a stronger diaphragm action to resist horizontal flood forces.

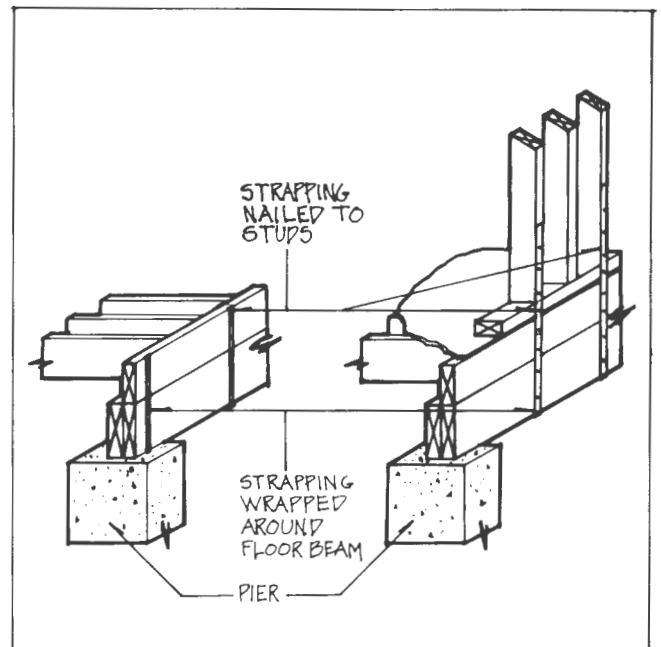

Figure 4.43. Metal Strapping



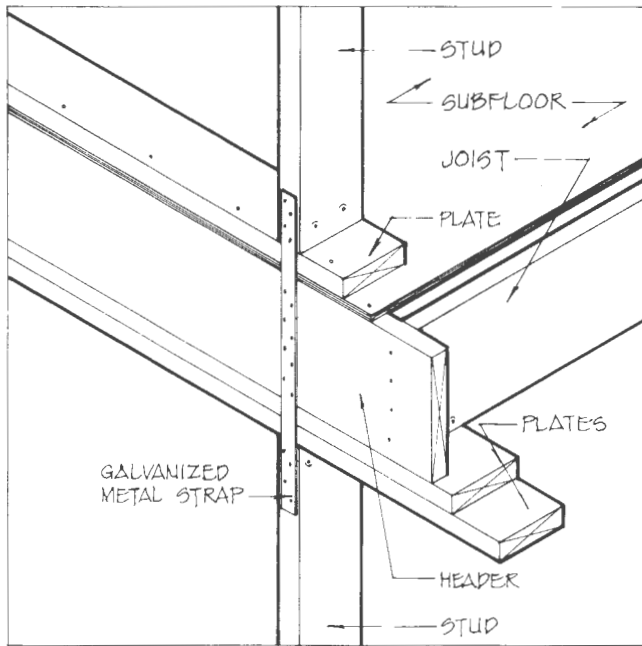

Figure 4.44. Stud-to-Stud Connections

## FLOOR-JOIST-TO-WALL CONNECTIONS

Elevated structures experience increased wind forces because wind speeds increase with elevation. Exterior walls are used as tension members to transfer wind uplift forces at the roof down to resistance provided by the foundation. It is usually necessary to use galvanized metal strap connections from alternate exterior wall studs to the floor joists or floor beams and from first floor studs to second floor studs (Figure 4.44). The capacity of these connections depends on the number of nails used. Manufacturers' brochures can be used to ascertain connectors' capacity and thus the spacing required.

## WALL SHEATHING

Plywood is the most common sheathing in use for exterior walls (Figures 4.45 and 4.46). The major advantages of plywood are that it braces the wall framing to resist racking stresses and it forms a continuous tie from floor beam to top plate when properly installed.

Plywood used for sheathing structures elevated up to 10 feet above the ground should be exterior grade and not less than 1/2-inch thick. Nailing should be with sixpenny nails, spaced 6 inches along the edges of the panel and 12 inches on intermediate studs.

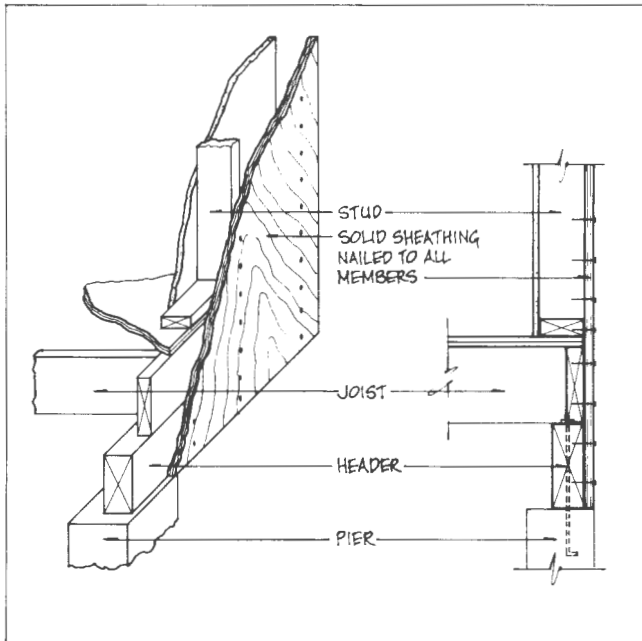

Figure 4.45. Plywood Anchorage

Structures elevated more than 10 feet should be sheathed with 3/4-inch exterior grade plywood, nailed with eightpenny nails, spaced as before. Deformed shank or annular ring nails and plywood with exterior glue are recommended.

## WALL BRACING

Bracing vertical walls against racking is a common building practice, especially for weak materials such as some of the newer insulated sheathing. Wind forces and lateral forces from moving water are also significant factors in determining whether and to what extent to brace vertical walls.

Common wall bracing methods are a let-in diagonal wood brace, diagonal boards and plywood. A common method similar to the let-in diagonal brace is a light-gauge galvanized steel strap nailed diagonally to each stud at the outside corners and framed walls.

## WALL-TO-ROOF CONNECTIONS

Probably the most critical structural connections for wind resistance are those between walls and the roof. For single-family residences, the roof structure is usually roof rafters of 2 x 10's or 2 x 12's or roof trusses built up of 2 x 4's or 2 x 6's. Whether rafters or trusses are used, they should be spaced at about 16 inches or 24 inches on center (16 inches is the more common spacing). Roof connections are critical because these connections are limited in number—at most they can occur at every roof rafter or truss.

A number of available galvanized metal connectors place the nails in an orientation to best resist uplift and lateral forces. Manufacturers' brochures provide the necessary design information.

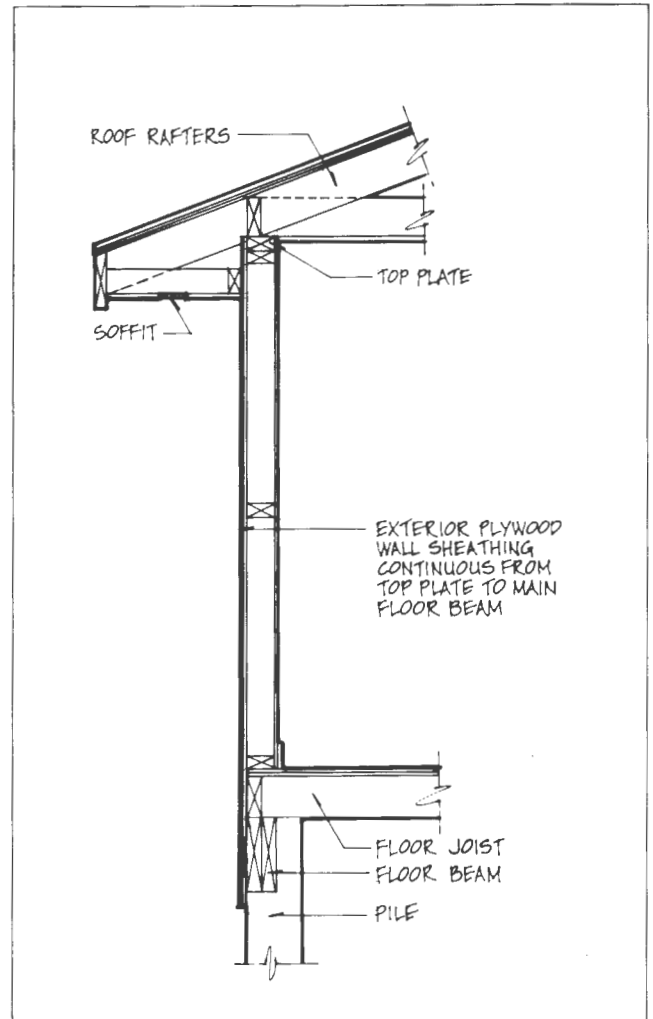

Figure 4.46. Wall Sheathing Tie from Roof to Ceiling

## Related Design Considerations

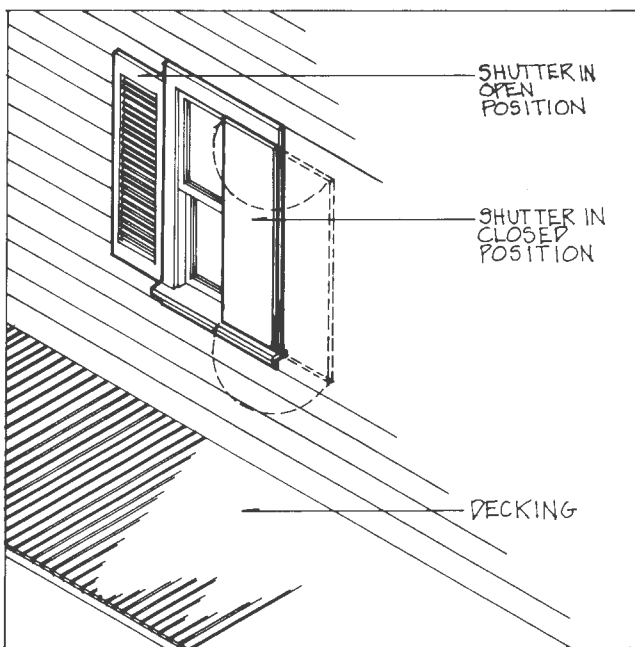

Figure 4.47. Shutters for Window Protection

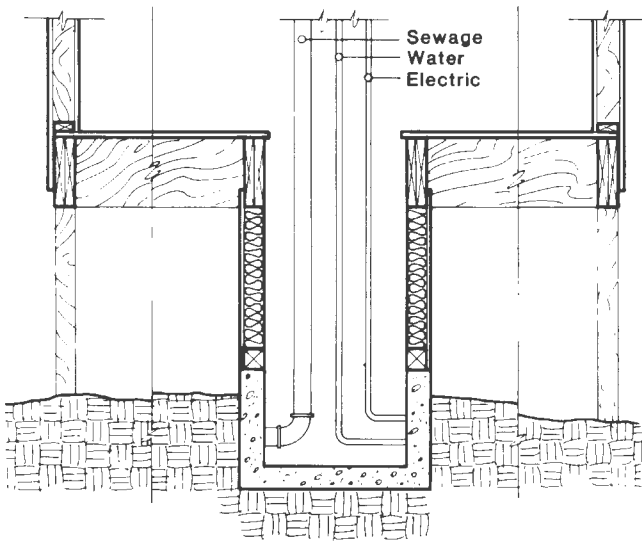

Figure 4.48. Protective Utility Shaft

### GLASS PROTECTION

Even moderate storms or routine high winds can cause large losses of glass in buildings, particularly along a coast. Broken glass may allow rain and floodwaters and high winds to enter the structure. Water damage can ruin furnishings and eventually damage structural members. Wind allowed into an elevated structure increases the uplift load on the structure as it applies pressure to the ceiling and wall surfaces.

Exterior shutters can be used to protect glass. For small openings the traditional louvered shutter offers some protection. Additional protection is possible using 1/2-inch plywood attached to the back of the shutter, which will take the direct forces from the storm (Figure 4.47). This method allows coverage of fairly large areas of glass.

### UTILITIES AND MECHANICAL EQUIPMENT

Structures in flood-prone areas are commonly served by combinations of electricity, water, sanitary sewer, gas (both natural and bottled), and telephone. Typical installations for these utilities expose them to potential damage from flooding and storm action. In the case of an elevated first floor, the connection from an underground utility line to the floor above further exposes the line to possible damage and/or contamination by flooding and storm action. Underground services are also susceptible to damage when erosion of the protective soil cover leaves them exposed during flooding.

Damage to utility lines can lead to contamination of drinking water, discharge of effluent from sewer lines, gas explosions, and fires and/or shock from damaged electrical systems.

The most vulnerable section of any underground utility line is the portion between the ground and the place it enters the elevated first floor. A minimum amount of protection can be obtained by locating these utility risers on the sides of interior elevated foundation elements opposite the direction

of flood water. This can minimize damage from velocity water or floating debris. A more secure method is to place all utility lines coming from underground within a protective, floodproofed shaft under the elevated first floor (Figure 4.48).

If electrical and telephone lines are supplied from overhead service lines, they should be connected through the utility company's meter system above the expected reach of flood waters. However, this requirement is often in conflict with the power company's policy regarding the reading of meters and their location. If this is not possible, the connection should be made within a waterproof enclosure. All distribution panels or other major electrical equipment should also be located above expected flood waters. Branch circuit wiring should be fed from the first floor ceiling downward to minimize wiring on the first floor.

All mechanical equipment (furnaces, hot water heaters, air-conditioners, water softeners) should also be elevated above expected flood waters (Figure 4.49). An attic location, if available, would provide the equipment maximum safety. Heating and/or cooling systems using ductwork to carry tempered air should be provided with emergency openings at their lowest elevations and a minimum slope on horizontal duct runs in order to allow the system to drain in case it becomes submerged. Figure 4.50 illustrates some of these concepts.

Septic tanks should be floodproofed to ensure that flooding does not cause the tank to rise out of the ground if the tank is partially empty, as well as to ensure against discharge of effluent.

## BUILDING MATERIALS

One way to increase the safety of building materials is to elevate the building higher than the minimum floodplain management requirements. Even then, however, flood waters may still reach building materials, so they should be protected.

A building elevated above grade has the underside of its floor area exposed to climatic and flood

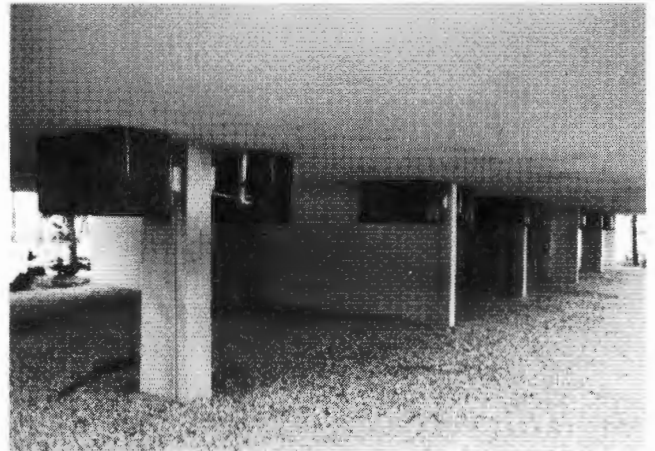

Figure 4.49. Elevated Condenser Units

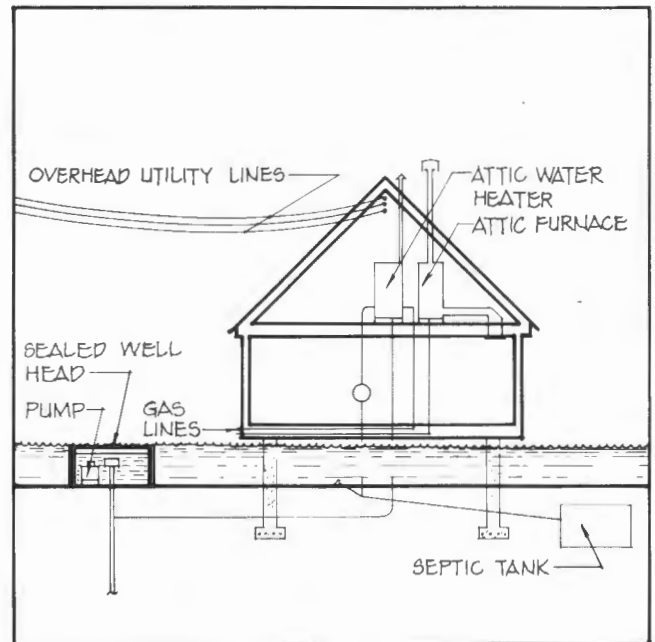

Figure 4.50. Locating Utilities

---

conditions, and will require special attention to protecting building materials. The climate and the desired appearance will determine whether the exposed underside of a floor should be sealed. Sealing exposed floors can protect subfloors and joists from the elements, improve insulation, and help conceal utilities.

The material used to enclose floor spaces should be resistant to water damage or inexpensive to replace if it is not resistant to damage. Exterior grade plywood treated with preservatives is water-resistant and can be effective. Gypsum products should not be used unless an acceptable level of performance is assured. Regardless of the material used, some provision must be made to allow water that may find its way into the floor sandwich during storms and flooding to drain out, and for the joist spaces to dry out.

#### Wood

Wood exposed to the elements should be protected by treatment with any one of a number of chemical preservatives to make the wood resistant to fungi attack, insects, bacteria, and rot. Connections should be designed so that water will not collect on or in them. They can be protected with protective flashing, by treating saw cuts and drill holes with preservatives, and by painting connections. The American Wood Preservers Institute, Tyson's International Building, 1945 Gallows Road, Vienna, Virginia 22180, can provide specific guidelines.

#### Steel

In riverine areas steel framing and foundation members exposed to the elements should be protected by galvanization or by painting with rust-retardant paints. The need for painting can be eliminated through the use of surface oxidizing steels (high strength low alloy).

In saltwater environments, exposed structural steel shapes, beams, pipes, channels, angles, etc., undergo very rapid corrosion, and their use should be avoided. Small connecting devices such as bolts, angles, bars, and straps should be hot-dipped galva-

---

nized after fabrication and coated with a protective paint after installation. Standard galvanized sheet metal joist hangers and other connecting devices deteriorate rapidly despite their galvanized coating and also require additional protective coatings. Small anchoring devices, nails, spikes, bolts, and lag screws should, whenever possible, be hot-dipped galvanized. With sheet metal clips and hangers, the special nails used should also be galvanized. Regular inspection, maintenance, and replacement of corroded metal parts is necessary when steel is used in the coastal environment. Steel rods used to reinforce concrete or masonry piles or piers require special precautions to prevent saltwater from reaching the steel through hairline cracks in concrete or through masonry joints. This is discussed below.

The American Iron and Steel Institute, 1000 Sixteenth Street, Washington, D.C. 20036, can provide specific guidelines.

### **Concrete and Masonry**

The durability of reinforced concrete and masonry block can be improved by the use of chemical additives mixed with the concrete and mortar and by special treatments and coatings. Additives are numerous and vary from those that will prevent spalling due to freezing to those that will improve strength. Surface treatments and coatings, such as silicone and epoxy paints, can be used to reduce water absorption and penetration and to prevent damage by airborne pollutants. Guidance in the use of concrete and masonry can be obtained from the Portland Cement Association, Old Orchard Road, Skokie, Illinois 60076, and the National Concrete Masonry Association, P.O. Box 781, Herndon, Virginia 22070.

### **INSULATION**

Like exposed walls of conventional structures, the exposed floor of elevated residences must be insulated against heat losses and heat gains. Depending on the climate, two factors should be considered. First, elevating a building will expose plumbing; such plumbing must be insulated against

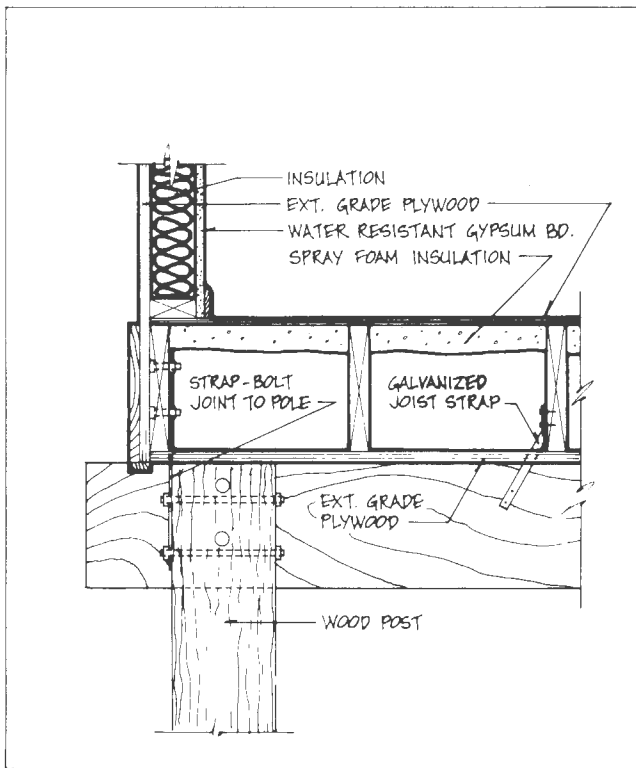

Figure 4.51. Insulated Floor Section, Wood Post Foundation

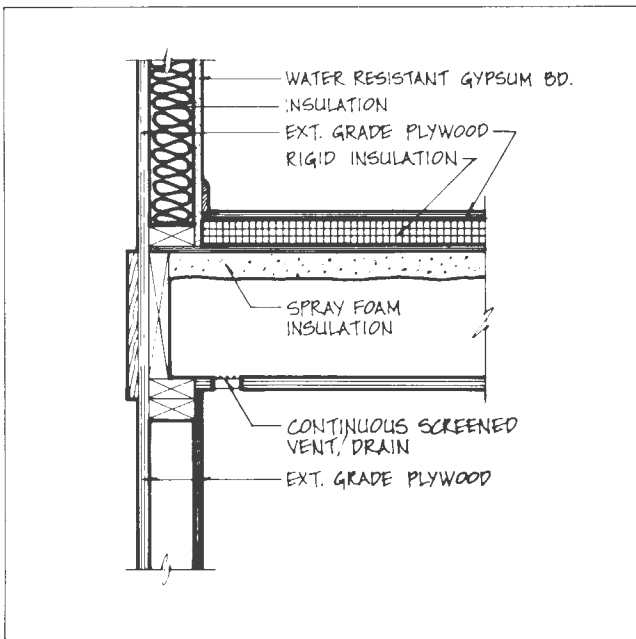

Figure 4.52. Insulated Floor Section, Foundation Wall

freezing. In extremely cold climates, heating cables may be necessary with the insulation. Second, insulated floor decks may be subject to floodwaters and should therefore have either impermeable, closed-pore insulation able to withstand water submersion or insulation that can be replaced economically (Figures 4.51 through 4.53).

## BREAKAWAY WALLS

As indicated in *Design and Construction Manual for Residential Buildings in Coastal High Hazard Areas*, cited in the Preface, the area under an elevated structure in a V Zone must be free of obstructions or be constructed with breakaway walls (e.g., latticework) designed to collapse under stress without jeopardizing the structural support of the building (Figure 4.54). Loads from flood waters and waterborne debris are critical considerations in designing breakaway walls.

## RETROFITTING EXISTING STRUCTURES

Existing residential structures in flood hazard areas can often be raised in-place to a higher elevation to reduce their susceptibility to flood damage. The principal consideration in raising existing structures is often the cost; generally, the technology exists to raise almost any structure, even multistory buildings, but the cost increases as the difficulty increases.

Residential structures have been satisfactorily raised up to nine feet. Aesthetics, intended use, needed flood elevation, and structural stability influence the height selected. Generally, the additional cost to raise a structure an additional foot or so is small compared to the initial set-up cost.

The new foundation for an existing structure should be selected and designed as discussed earlier.

Raising in-place is generally feasible for structures that are 1) accessible below the first floor for placement of jacks and beams, 2) light enough to

be jacked with conventional house moving equipment, 3) small enough that they can be raised in one piece, and 4) strong enough to withstand the stress of the raising process.

Wood frame residential and light commercial structures with first floors above the ground (normally with an 18-inch crawl space beneath the first floor) are particularly suited for raising. Wood frame structures with basements below the first floor are also accessible and lightweight; however, raising the superstructure does not protect the basement, and the basement should be filled with a granular material to provide structural stability for the walls. Brick, brick veneer, and masonry structures, while heavier and more difficult to handle, can also be raised.

Utility equipment located in a basement can often be moved to a higher room, such as an upstairs closet, or an attic. It is important to ensure that the closet or attic floor can support the weight of the equipment. If necessary, an elevated addition can be built to house a furnace, hot water heater, and other equipment formerly housed in a basement. Protecting utility equipment in this way can be useful even if the house itself cannot or need not be raised.

Raising a structure usually involves the following steps:

- Disconnect all plumbing, wiring, and utilities that cannot be raised with the structure.
- Place steel beams and hydraulic jacks beneath the structure and raise to desired elevation.
- Extend existing foundation walls and piers or construct new foundation.
- If a basement exists, remove water heater, furnace, etc., and fill basement with granular material to support basement walls.
- Lower the structure onto the extended or new foundation.
- Adjust walks, steps, ramps, plumbing, and utilities and regrade site as desired.
- Reconnect all plumbing, wiring, and utilities.
- Insulate exposed floor to reduce heat loss and protect plumbing, wiring, utilities and insulation from possible water damage.

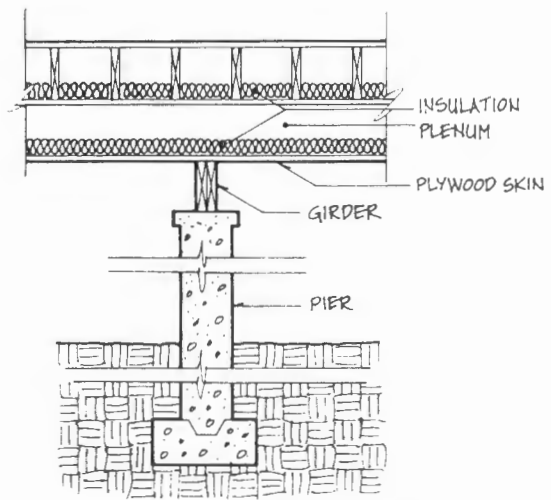

Figure 4.53. Double-Insulated Floor Plenum, Pier Foundation



Figure 4.54. Breakaway Walls



# COST ANALYSIS



---

Once a community decides that the economic risk and environmental impact of developing floodplain land for residential use is acceptable, the dollar cost of that development must be evaluated. Two factors bear significantly on any such evaluation: first, the net cost of construction that meets the standards of the National Flood Insurance Program (NFIP) in light of the potential and unpredictable hazard of flooding and the losses that may ensue; second, the cost differentials between construction on elevated foundations and conventional building methods. (Note that standards adapted by local jurisdictions are often more stringent than the NFIP's.)

Repeated studies have shown that the savings that can be realized over the lifetime of a structure by building on a raised foundation are usually considerable when compared with the one-time increase in construction costs for an elevated foundation. This is largely because the one-time foundation costs are generally only five or six percent of the total cost of a residential structure, while the flood insurance savings that can be achieved over the life of a structure by elevating it can be considerable.

The economic cost to the individual of building a home in the floodplain consists of both flood damages that will occur and the costs of whatever measures are taken to mitigate such damages. The cost of flood damages to the homeowner may be partially shifted to federal, state, and local government through low-interest loans and tax deductions for losses incurred. In communities participating in the NFIP, the owner of a new home can purchase flood insurance. Essentially, flood insurance allows the homeowner to spread the flood risk to others facing the same hazards and, more importantly, permits one to pay for expected flood losses, which are unpredictable as to size and time of occurrence, in predictable annual payments. These are more manageable than unexpected flood losses, especially if more than one large flood happens to occur in a very short time.

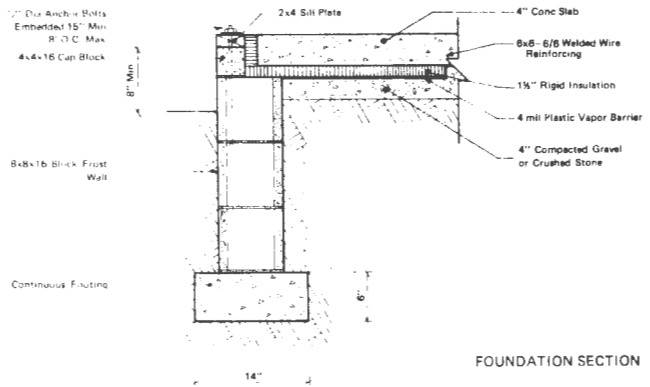
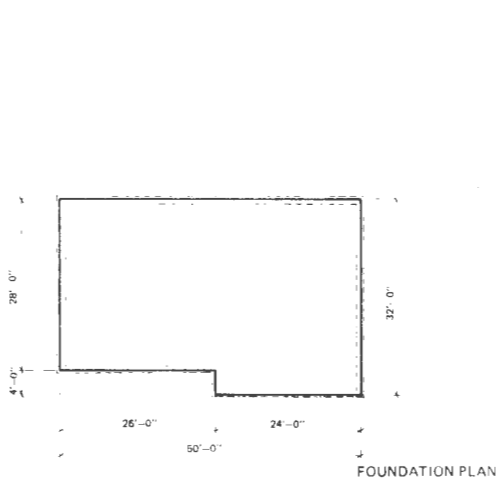

SLAB-ON-GRADE \$4.61 per square foot

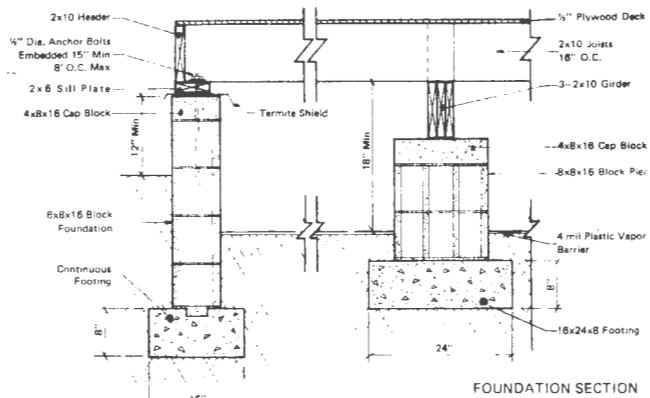
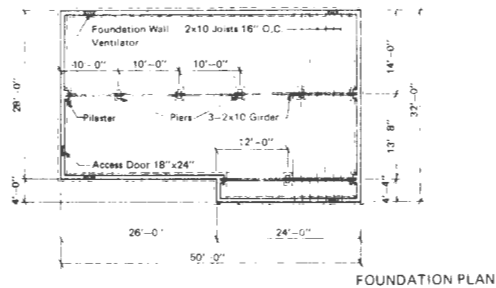

CRAWL SPACE \$5.13 per square foot

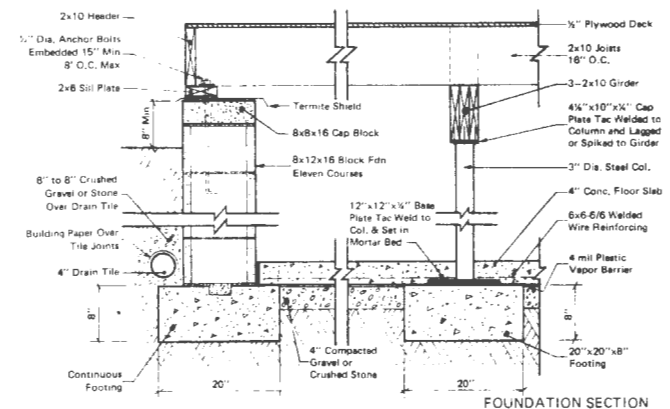
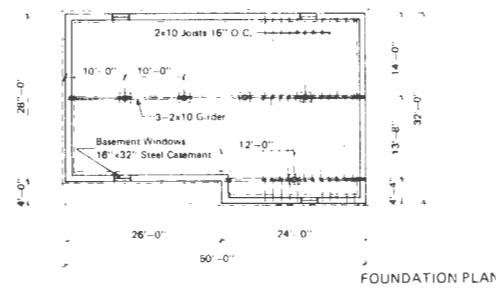

BASEMENT \$11.01 per square foot

Figure 5.1. Conventional Foundations (Estimates are spring 1983.)

## COST COMPARISON APPROACH

The costs of post, pile, and pier foundations are compared here to each other and to the costs of conventional slab, crawl space, and basement foundations. Cost data and estimating forms are provided for roughly estimating one's particular foundation costs.

1. *Slab-on-grade, crawl space, and basement foundations* were selected as three of the most common types of residential foundations, and detailed drawings of them were prepared (Figure 5.1). Detailed drawings were also prepared for the three most typical elevation foundation types. These are post, pile, and pier foundations (Figure 5.2). (Regarding use of earth fill, see below.)

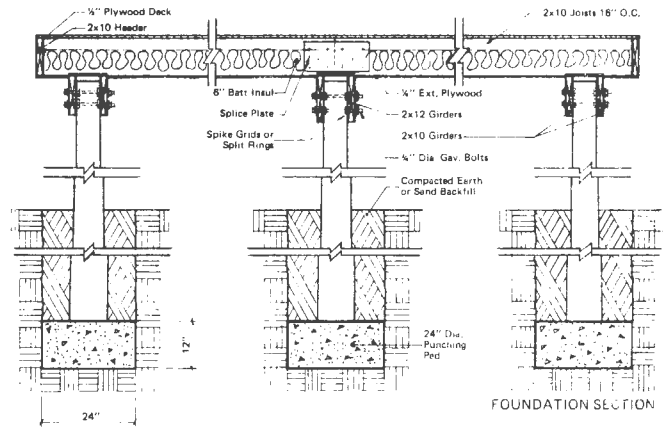

WOOD POST \$6.96 per square foot

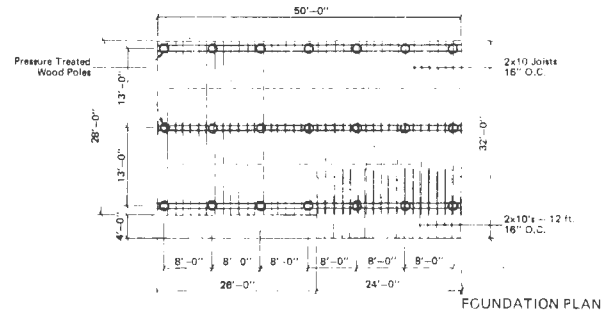

FOUNDATION PLAN

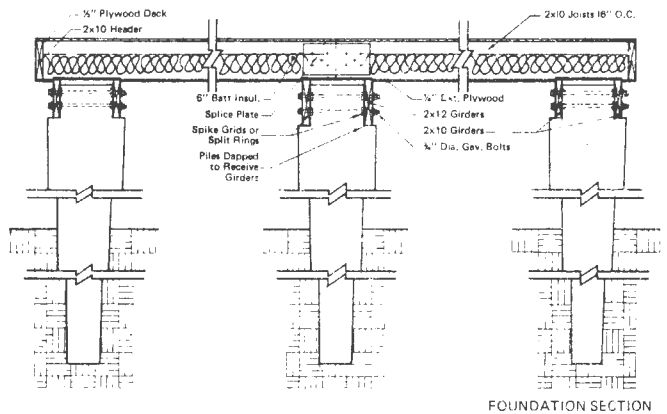

FOUNDATION SECTION

WOOD PILE \$6.58 per square foot

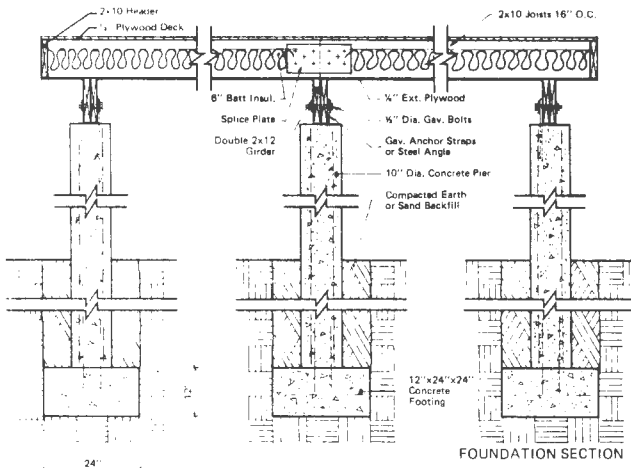

FOUNDATION SECTION

CONCRETE PIER \$7.08 per square foot

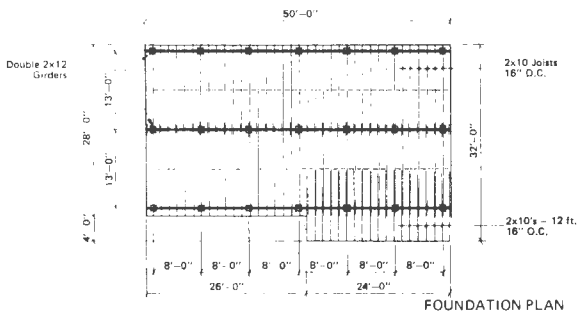

FOUNDATION PLAN

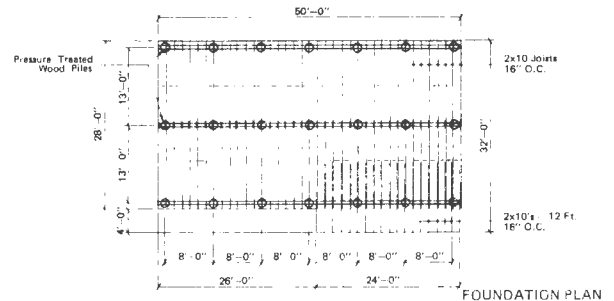

FOUNDATION PLAN

Figure 5.2. Elevated Foundations (Estimates are spring 1983.)

**Conventional Foundations**

Slab-on-Grade	\$4.61 per sq. ft.
Crawl Space	\$5.13 per sq. ft.
Basement	\$11.01 per sq. ft.

**Elevated Foundations**

Wood Post	\$6.96 per sq. ft.
Wood Pile	\$6.58 per sq. ft.
Concrete Pier	\$7.08 per sq. ft.

Estimates—Spring 1983

- The estimates are summarized in Figure 5.3. They are based on the foundation and deck of a 1,500-square-foot house, 28'x50', with a small offset. The total cost of this house is approximately \$60,000, excluding land. All estimates were based on FHA construction practices.
- Using data from this cost sampling, the average cost of each conventional foundation type is compared to the average cost of each elevated foundation type. This comparison is done in two ways: first, each foundation as a percentage of the cost of the *entire* house (conventional foundations were established as base 100) and, second the dollar increase in the cost of the foundation above.

Figure 5.3. Foundation Cost Estimates

	Elevated Foundations	Conventional Foundations		
		Slab on Grade	Crawl Spaces	Basement
% Increase of Total House Cost	Wood Post	+5.9	+4.6	-10.1
	Wood Pile,	+4.9	+3.6	-11.1
	Concrete Pier	+6.2	+4.9	-9.8
Dollar Increase, Foundation Cost Only	Wood Post	\$3,525	\$2,745	-\$6,075
	Wood Pile	\$2,955	\$2,175	-\$6,645
	Concrete Pier	\$3,707	\$2,925	-\$5,895

Figure 5.4 Cost Differentials, Conventional Vs. Elevated Foundations, for House Costing \$60,000, Excluding Land.

4. Figure 5.5 graphically compares the cost of constructing the different types of foundations at various elevations. Note that increasing the elevation increases costs at a substantial rate only in the case of the fill option (which is based on the availability of usable fill material on the site).

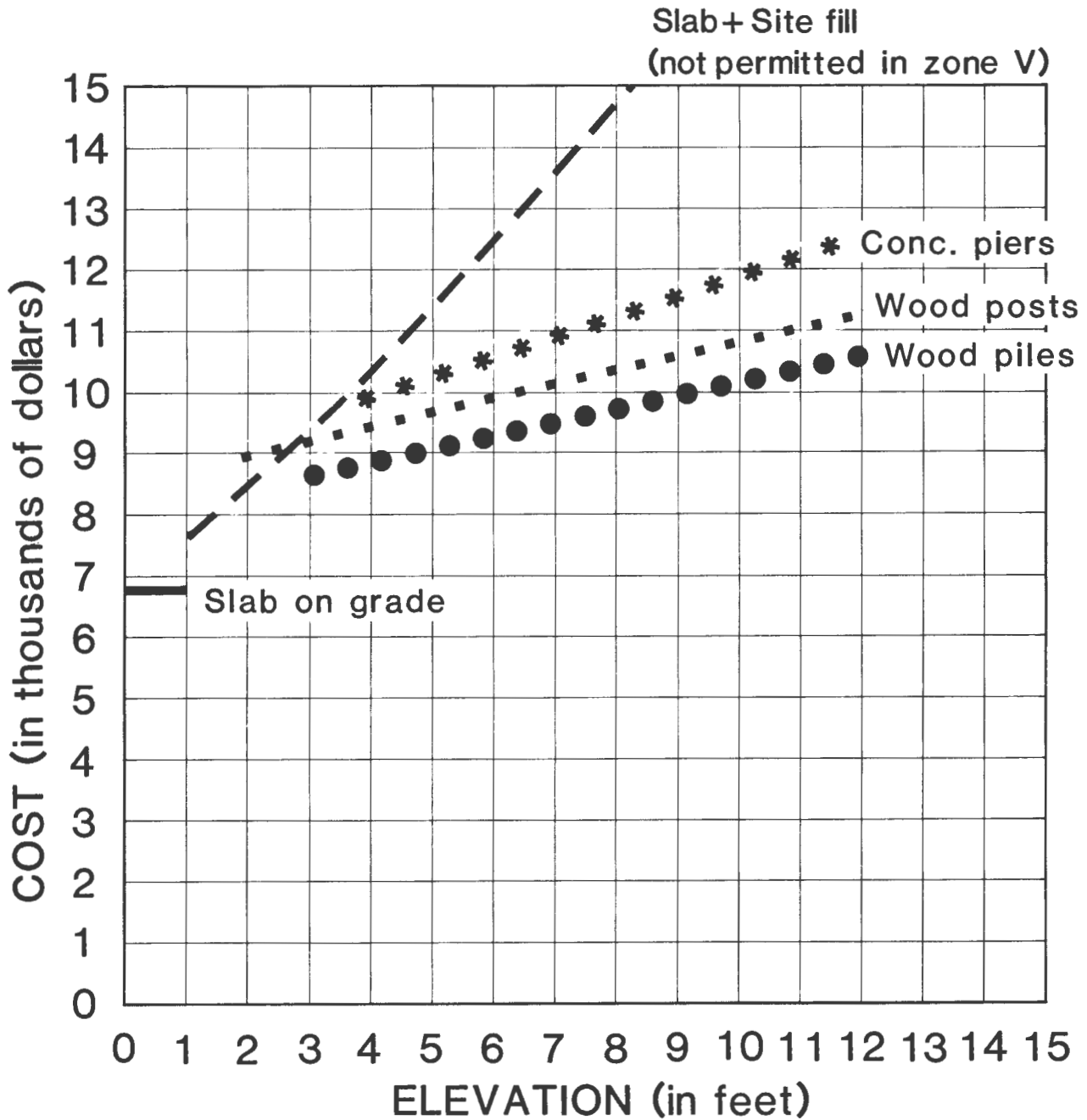

Figure 5.5. Relative Costs of Foundations Elevated to Different Heights

---

## Fill

Fill can often be used in A Zones to elevate conventional foundations such as slab-on-grade. The cost of this approach varies widely, depending on the availability, quality, and unit cost of fill as well as the height and compaction necessary. Local building officials or soils engineers should be consulted to evaluate local conditions.

## COST COMPARISON CAVEATS

The comparative cost data given above do not take into account a number of factors that can affect either basic construction costs or long-term insurance costs.

### Insurance Costs

Insurance rates under the NFIP vary greatly depending on the elevation of a building and other features related to flood safety. Differences in these rates can overshadow the construction cost differentials discussed in this chapter, and should be considered carefully in making design decisions.

### Design Assumptions

Each house elevated on piles, posts, and piers was assumed to have 21 foundation elements. In addition, each element was assumed to be an average length that included the length below grade and the length between grade and the structure. These lengths are 16 feet for piles, 14 feet for posts, and 15 feet for piers. In practice, both the number and length of foundation elements will vary depending on soil conditions, expected flood levels, etc.

### Earthquakes

Constructing elevated foundations in earthquake areas may require additional structural expenditures that should be noted in cost estimates. Local building officials or a structural engineer should be consulted to evaluate local conditions.

---

## **Stairs and Utilities**

Elevating a residence may result in increased cost for stairs and for utilities that must be elevated above grade. These costs were not considered in the estimates presented here since they vary with height of elevation, cost assignment, i.e., who pays for installation of utilities, and elevation method.

## **Regional Cost Variations**

The cost data presented above are based on national averages, and do not take into account regional cost variations.

## **Cost Inflation**

Building costs are difficult to predict because of the tendency for the cost of basic construction commodities—lumber, concrete, and steel—to fluctuate and to vary relative to each other. The costs here are estimated using data for the spring of 1983.

## **Non-Cost Considerations**

Cost is not the only determinant for selecting the material and method for elevating. Market acceptance (buyers and banks), architectural design integration, climatic conditions, site conditions, and anticipated flood hazards should also be considered.

## **ESTIMATING FORMS**

The forms on the following pages can be used for making cost estimates for conventional and elevated foundations.





**CRAWL SPACE**

**ESTIMATING FORM  
TO DETERMINE LOCAL COSTS**

Compute the following and enter:

\_\_\_\_\_ *Square Footage of Floor Area*  
 \_\_\_\_\_ *Lineal Footage of Perimeter*  
 \_\_\_\_\_ *Square Footage of Foundation Wall*  
 \_\_\_\_\_ *Number of Piers*

Enter your costs (combine labor and material) and extend:

<i>Layout house on lot</i>			= \$ _____
<i>Trench for footing</i>	_____	x _____	LF = \$ _____
<i>Place footings</i>	_____	x _____	LF = \$ _____
<i>Lay-up or form and pour foundation wall</i>	_____	x _____	SF = \$ _____
<i>Place pier footings</i>	_____	x _____	Ea. = \$ _____
<i>Lay-up or form and pour piers</i>	_____	x _____	Ea. = \$ _____
<i>Backfill</i>	_____	x _____	CY = \$ _____
<i>Floor Girder</i>	_____	x _____	LF = \$ _____
<i>Floor Framing</i>	_____	x _____	SF = \$ _____
<i>Insulation &amp; sealer</i>	_____	x _____	SF = \$ _____
<i>Subfloor</i>	_____	x _____	SF = \$ _____
<i>Place floor slab</i>	_____	x _____	SF = \$ _____
		<i>Grand Total</i>	\$ _____

**BASEMENT**

**ESTIMATING FORM  
TO DETERMINE LOCAL COSTS**

Compute the following and enter:

- \_\_\_\_\_ *Square Footage of Floor Area*
- \_\_\_\_\_ *Lineal Footage of Perimeter*
- \_\_\_\_\_ *Square Footage of Basement Wall Area*
- \_\_\_\_\_ *Number of Basement Support Columns*

Enter your costs (combine labor and materials) and extend:

<i>Layout house on lot</i>			= \$ _____
<i>Excavation &amp; spoil removal</i>	_____ x _____	<i>SF</i>	= \$ _____
<i>Place footings</i>	_____ x _____	<i>LF</i>	= \$ _____
<i>Place pier footings</i>	_____ x _____	<i>Ea.</i>	= \$ _____
<i>Lay-up or form &amp; pour foundation wall</i>	_____ x _____	<i>SF</i>	= \$ _____
<i>Parge wall</i>	_____ x _____	<i>SF</i>	= \$ _____
<i>Set drain tile</i>	_____ x _____	<i>LF</i>	= \$ _____
<i>Backfill</i>	_____ x _____	<i>CY</i>	= \$ _____
<i>Place vapor barrier and wire mesh</i>	_____ x _____	<i>SF</i>	= \$ _____
<i>Place and finish floor slab</i>	_____ x _____	<i>SF</i>	= \$ _____
<i>Place girder</i>	_____ x _____	<i>LF</i>	= \$ _____
<i>Frame Floor</i>	_____ x _____	<i>SF</i>	= \$ _____
<i>Place subfloor</i>	_____ x _____	<i>SF</i>	= \$ _____
	<i>Grand Total</i>		\$ _____

**WOOD POST**

**ESTIMATING FORM  
TO DETERMINE LOCAL COSTS**

Compute the following and enter:

\_\_\_\_\_ *Square Footage of Floor Area*  
\_\_\_\_\_ *Lineal Footage of Girders*  
\_\_\_\_\_ *Number of Posts*

Enter your costs (combine labor and material) and extend:

*Layout house on lot* = \$ \_\_\_\_\_

*Auger or dig post holes  
and remove spoil* \_\_\_\_\_ x \_\_\_\_\_ Qty = \$ \_\_\_\_\_

*Place concrete punching  
pad* \_\_\_\_\_ x \_\_\_\_\_ Qty = \$ \_\_\_\_\_

*Place poles* \_\_\_\_\_ x \_\_\_\_\_ Qty = \$ \_\_\_\_\_

*Backfill poles and plumb* \_\_\_\_\_ x \_\_\_\_\_ Qty = \$ \_\_\_\_\_

*Set girder* \_\_\_\_\_ x \_\_\_\_\_ LF = \$ \_\_\_\_\_

*Frame floor* \_\_\_\_\_ x \_\_\_\_\_ SF = \$ \_\_\_\_\_

*Place insulation & sealer* \_\_\_\_\_ x \_\_\_\_\_ SF = \$ \_\_\_\_\_

*Place subfloor* \_\_\_\_\_ x \_\_\_\_\_ SF = \$ \_\_\_\_\_

*Grand Total* \$ \_\_\_\_\_

Compute the following and enter:

\_\_\_\_\_ *Square Footage of Floor Area*  
 \_\_\_\_\_ *Lineal Footage of Girders*  
 \_\_\_\_\_ *Number of Piles*  
 \_\_\_\_\_ *Total Lineal Footage of Piles*

Enter your costs (combine labor and material) and extend:

*Layout house on lot* \_\_\_\_\_ = \$ \_\_\_\_\_

*Bring pile-driving equip-  
ment to site* \_\_\_\_\_ x \_\_\_\_\_ = \$ \_\_\_\_\_

*Furnish and drive piles* \_\_\_\_\_ x \_\_\_\_\_ *LF* = \$ \_\_\_\_\_

*Set girder* \_\_\_\_\_ x \_\_\_\_\_ *LF* = \$ \_\_\_\_\_

*Frame floor* \_\_\_\_\_ x \_\_\_\_\_ *SF* = \$ \_\_\_\_\_

*Place insulation and  
sealer* \_\_\_\_\_ x \_\_\_\_\_ *SF* = \$ \_\_\_\_\_

*Place subfloor* \_\_\_\_\_ x \_\_\_\_\_ *SF* = \$ \_\_\_\_\_

*Grand Total* \_\_\_\_\_ \$ \_\_\_\_\_

CONCRETE PIER

ESTIMATING FORM  
TO DETERMINE LOCAL COSTS

Compute the following and enter:

\_\_\_\_\_ *Square Footage of Floor Area*  
\_\_\_\_\_ *Lineal Footage of Girder*  
\_\_\_\_\_ *Number of Piers*

Enter you costs (combine labor and material) and extend:

*Layout house on lot* = \$ \_\_\_\_\_

*Auger or dig pier holes  
and remove spoil* \_\_\_\_\_ x \_\_\_\_\_ *Qty = \$* \_\_\_\_\_

*Place concrete footing* \_\_\_\_\_ x \_\_\_\_\_ *Qty = \$* \_\_\_\_\_

*Form & pour piers* \_\_\_\_\_ x \_\_\_\_\_ *Qty = \$* \_\_\_\_\_

*Backfill* \_\_\_\_\_ x \_\_\_\_\_ *Qty = \$* \_\_\_\_\_

*Set girder* \_\_\_\_\_ x \_\_\_\_\_ *LF = \$* \_\_\_\_\_

*Frame floor* \_\_\_\_\_ x \_\_\_\_\_ *SF = \$* \_\_\_\_\_

*Place insulation  
and sealer* \_\_\_\_\_ x \_\_\_\_\_ *SF = \$* \_\_\_\_\_

*Place subfloor* \_\_\_\_\_ x \_\_\_\_\_ *SF = \$* \_\_\_\_\_

*Grand Total* \$ \_\_\_\_\_

# RESOURCE MATERIALS

---



# Glossary

---

## Base Flood Elevation (BFE)

The elevation for which there is a one-percent chance in any given year that flood levels will equal or exceed it (see *Special Flood Hazard Areas*). The BFE is determined by statistical analysis of stream-flow records for the watershed and rainfall and runoff characteristics in the general region of the watershed.

## Coastal High Hazard Area

The portion of a coastal floodplain that is subject to high velocity waters caused by tropical storms, hurricanes, northeasters, or tsunamis. Labeled V Zones on Flood Insurance Rate Maps, these areas experience breaking waves of three feet or more.

## Debris Impact Loads

Loads induced on a structure by solid objects carried by flood water. Debris can include trees, lumber, displaced sections of structures, tanks, runaway boats, and chunks of ice. Debris impact loads are difficult to predict accurately, yet reasonable allowances must be made for them in the design of potentially affected structures.

## Encroachment

Any physical object placed in a floodplain that hinders the passage of water or otherwise affects flood flows.

## Existing Construction

Those structures already existing or on which construction or substantial improvement was started prior to the effective date of a community's floodplain management regulations.

## Flood or Flooding

A general and temporary condition of partial or complete inundation of normally dry land areas. Flooding results from the overflow of inland or tidal waters or the unusual and rapid accumulation of surface water runoff from any source.

## Flood Insurance Rate Map (FIRM)

An official map of a community, issued or approved by the Federal Emergency Management Agency, that delineates both the special hazard areas and the risk premium zones applicable to the community. Zones are as follows:

**Zone A (unnumbered)** - special flood hazard area inundated by the 100-year flood; determined by approximate methods with no base flood elevation shown.

**Zones A1–A30** - special flood hazard area inundated by the 100-year flood; determined by detailed methods with base flood elevations shown.

**Zone B** - area between the limits of the 100-year flood and the 500-year flood, or certain areas subject to 100-year flooding with average depths less than 1 foot, or areas protected by levees from the base flood.

**Zone C** - area of minimal flooding; located outside the limits of the 500-year flood.

**Zone V (unnumbered)** - area subject to wave action, without base flood elevation shown.

**Zones V1-V30** - special flood hazard area of 100-year coastal flooding with velocity (wave action); base flood elevations shown.



---

## **Floodplain**

Any normally dry land area that is susceptible to being inundated by water from any natural source. This area is usually low land adjacent to a river, stream, watercourse, ocean, or lake.

## **Floodplain Management**

The operation of a program of corrective and preventive measures for reducing flood damage, including but not limited to flood control projects, floodplain land-use regulations, flood-proofing of buildings, and emergency preparedness plans.

## **Floodway**

The channel of a river or watercourse and the adjacent land areas that must be reserved to discharge the one-percent-probability flood without cumulatively increasing the water surface elevation more than a designated height, generally one foot.

## **Hydrology**

The science of the behavior of water in the atmosphere, on the earth's surface, and underground.

## **Hydrodynamic Loads**

As flood water flows around a structure it imposes loads on the structure. These loads consist of frontal impact by the mass of moving water against the structure, drag effect along the sides of the structure, and eddies or negative pressure on the structure's downstream side.

## **Hydrostatic Loads**

Those loads or pressures resulting from the static mass of water at any point of flood water contact with a structure. They are equal in all directions and always act perpendicular to the surface on which they are applied. Hydrostatic loads can act vertically on structural members such as

floors, decks, and roofs, and can act laterally on upright structural members such as walls, piers, and foundations.

## **Mean Sea Level**

The average height of the sea for all stages of the tide, usually determined from hourly height observations over a nineteen-year period on an open coast or in adjacent waters having free access to the sea.

## **New Construction**

Structures on which construction or substantial improvement was started after the effective date of a community's floodplain management regulations.

## **One-Hundred Year Flood**

(See *Special Flood Hazard Areas*).

## **Permeability**

The property of soil or rock that allows passage of water through it.

## **Regulatory Floodway**

Any floodway referenced in a floodplain ordinance for the purpose of applying floodway regulations.

## **Special Flood Hazard Areas**

Areas in a community that have been identified as susceptible to a one-percent or greater chance of flooding in any given year. A one-percent probability flood is also known as the 100-year flood or the base flood.

## **Stillwater Elevations**

The elevation that the surface of the water would assume if all wave action were absent.

---

### Storm Surge

A rise above normal water level on the open coast due to the action of wind stress and atmospheric pressure on reduction on the water surface.

### Substantial Improvement

Any repair, reconstruction, or improvement of a structure, the cost of which equals or exceeds 50 percent of the market value of the structure either (a) before the improvement is started or (b) if the structure has been damaged, and is being restored, before the damage occurred.

### Watershed

An area from which water drains to a single point; in a natural basin, the watershed is the area contributing flow to a given place or stream.

### Wave Height

The vertical distance between a wave crest and the preceding trough.

### Wave Crest Elevation

The elevation of the 100-year storm surge plus wave height.



# Sources of Design Information

Regulatory Information

Information Required	Purpose or Implications of Data	Possible Forms of Data	Potential Sources of Data
<ul style="list-style-type: none"> <li>National Flood Insurance Program (NFIP)</li> </ul>	<ul style="list-style-type: none"> <li>Requires local communities to implement floodplain regulations</li> <li>Sets minimum standards for floodplain regulations</li> <li>Prohibits federal funding for projects in violation of floodplain regulations</li> <li>Prohibits federal loan guarantees for projects in violation of floodplain regulations</li> <li>Establishes flood insurance rate differentials for properties in flood-prone areas</li> </ul>	<ul style="list-style-type: none"> <li>Program regulations</li> <li>Insurance rate information and tables</li> <li>Flood Insurance Studies</li> <li>Flood Maps</li> <li>Section 1362 Guidelines</li> </ul>	<ul style="list-style-type: none"> <li>Federal Insurance Administration</li> <li>Federal Emergency Management Agency</li> <li>State Floodplain Management Coordinating Agency</li> <li>Local Government Planning Agency</li> </ul>
<ul style="list-style-type: none"> <li>Local Government Planning Programs</li> </ul>	<ul style="list-style-type: none"> <li>Implements floodplain regulations</li> <li>Determines local floodplain regulations based on NFIP guidelines (includes zoning and subdivision regulations, performance standards, Planned Unit Development ordinances, building codes, etc.)</li> <li>Note: Local regulations can be set at a higher standard than NFIP minimum standards, depending on local needs and circumstances</li> </ul>	<ul style="list-style-type: none"> <li>Planning and Zoning Ordinances</li> <li>Zoning Maps</li> <li>Building Codes</li> </ul>	<ul style="list-style-type: none"> <li>Local Government Planning Agency</li> <li>Local Government Engineer</li> <li>Building Code Officials</li> </ul>
<ul style="list-style-type: none"> <li>State Floodplain and Coastal Zone Programs</li> </ul>	<ul style="list-style-type: none"> <li>Provides statewide floodplain development regulations and guidelines</li> <li>Regulates development in coastal zones</li> <li>Coordinates implementation of NFIP in local jurisdictions and in areas where multiple state agencies have an interest in flooding</li> <li>Clearinghouse for Floodplain Management Information</li> </ul>	<ul style="list-style-type: none"> <li>State program regulations</li> <li>State development guidelines</li> </ul>	<ul style="list-style-type: none"> <li>State Floodplain Management Coordinating Agency</li> <li>State Office of Coastal Zone Management</li> <li>State Office of Natural or Water Resources</li> </ul>
<ul style="list-style-type: none"> <li>Regional Planning Restrictions or Guidelines</li> </ul>	<ul style="list-style-type: none"> <li>Can provide additional regulations and guidelines for regional jurisdictions</li> <li>Coordinates activities of different agencies within the region</li> <li>Source of information and, in some cases, technical assistance</li> </ul>	<ul style="list-style-type: none"> <li>Program regulations</li> <li>Development guidelines</li> </ul>	<ul style="list-style-type: none"> <li>Regional Authorities (e.g., Tennessee Valley Authority, Appalachian Regional Commission, etc.)</li> <li>Regional Planning Commissions</li> <li>River Basin Commissions</li> </ul>
<ul style="list-style-type: none"> <li>Federal Agency Requirements and Guidelines (other than NFIP)</li> </ul>	<ul style="list-style-type: none"> <li>May include regulations relating to development in flood-prone areas (e.g., Corps of Engineers permits for development on navigable rivers)</li> <li>May involve federal funding, the use of which is restricted in flood-prone areas</li> <li>Projects may require federal approval for development in flood-prone areas (e.g., Environmental Impact Statements)</li> </ul>	<ul style="list-style-type: none"> <li>Program regulations</li> </ul>	<ul style="list-style-type: none"> <li>U.S. Army Corps of Engineers</li> <li>Environmental Protection Agency</li> <li>Federal Emergency Management Agency</li> <li>State Floodplain Management Coordinating Agency</li> <li>Local Planning Agency</li> </ul>

Hydrologic Data

Information Required	Purpose or Implications of Data	Possible Forms of Data	Potential Sources of Information
<ul style="list-style-type: none"> <li>Flood Hazard Boundaries</li> </ul>	<ul style="list-style-type: none"> <li>Determines where floodplain regulations, insurance, and federal financing restrictions apply</li> <li>Determines specific flood hazard zones</li> <li>Determines variable flood insurance rate zones</li> </ul>	<ul style="list-style-type: none"> <li>Flood Hazard Boundary Maps</li> <li>Flood Insurance Rate Maps</li> <li>Flood Boundary and Floodway Maps</li> <li>Hydrologic Atlases</li> <li>Local Zoning Maps</li> <li>Flood Insurance Studies</li> </ul>	<ul style="list-style-type: none"> <li>Local Government Planning Agency</li> <li>Local Government Municipal Engineer</li> <li>State Floodplain Coordinating Agency</li> </ul>
<ul style="list-style-type: none"> <li>Flood Depths</li> </ul>	<ul style="list-style-type: none"> <li>Indicates elevations at which flood damage is likely to occur</li> <li>Determines appropriate building elevations for meeting floodplain regulations and flood insurance restrictions and rates</li> <li>Indicates hydrostatic loads in flood-prone areas</li> </ul>	<ul style="list-style-type: none"> <li>Flood Elevations</li> <li>Water Surface Profiles</li> <li>Stream and Coast Cross-sections</li> <li>Flood Insurance Studies</li> </ul>	<ul style="list-style-type: none"> <li>State Office of Natural Resources</li> <li>Federal Insurance Administration</li> <li>Federal Emergency Management Agency</li> </ul>
<ul style="list-style-type: none"> <li>Flood Water Velocity</li> </ul>	<ul style="list-style-type: none"> <li>Determines hydrodynamic loads in flood-prone areas</li> <li>Determines debris-impact loads in flood-prone areas</li> <li>Indicates potential for erosion and slope deterioration</li> </ul>	<ul style="list-style-type: none"> <li>Floodplain Technical Studies</li> <li>Hydrologic Studies</li> <li>Flood Insurance Studies</li> </ul>	<ul style="list-style-type: none"> <li>U.S. Army Corps of Engineers</li> <li>U.S. Geologic Survey</li> </ul>

<ul style="list-style-type: none"> <li>Warning Time</li> </ul>	<ul style="list-style-type: none"> <li>Indicates importance of emergency evacuation as part of the design program</li> <li>Influences design of floodproofing techniques such as floodshields</li> <li>Influences design of drainage systems</li> <li>Influences design of wet floodproofing techniques</li> </ul>	<ul style="list-style-type: none"> <li>Hydrographs</li> <li>Floodplain Technical Studies</li> <li>Historical Records</li> <li>Flood Insurance Studies</li> </ul>	<ul style="list-style-type: none"> <li>Regional Authorities <ul style="list-style-type: none"> <li>Tennessee Valley Authority</li> <li>Appalachian Regional Commission</li> <li>River Basin Commissions</li> </ul> </li> <li>Hydrologic Engineering Consultants</li> </ul>
<ul style="list-style-type: none"> <li>Duration of Flooding</li> </ul>	<ul style="list-style-type: none"> <li>Affects seepage into buildings and saturation of soils and building materials</li> <li>Affects the length of time facilities might be inaccessible or inoperable</li> <li>Affects building design relative to orientation, configuration, and choice of floodproofing techniques</li> </ul>	<ul style="list-style-type: none"> <li>Floodplain Technical Studies</li> <li>Historical Records</li> <li>Flood Insurance Studies</li> </ul>	<ul style="list-style-type: none"> <li>Surveys by Professional Staff</li> <li>U.S. Department of the Interior Water and Power Resources Service (operates west of the Mississippi River)</li> </ul>
<ul style="list-style-type: none"> <li>Frequency of Flooding</li> </ul>	<ul style="list-style-type: none"> <li>Influences site choice</li> <li>Affects choice of floodproofing techniques especially those that require installation before every flood</li> <li>Indicates need for special access</li> </ul>	<ul style="list-style-type: none"> <li>Floodplain Technical Studies</li> <li>Historical Records</li> </ul>	
<ul style="list-style-type: none"> <li>Climate and Weather</li> </ul>	<ul style="list-style-type: none"> <li>Indicates frequency and type of precipitation and, in turn, the type and magnitude of flooding that is likely</li> </ul>	<ul style="list-style-type: none"> <li>Weather Service Records</li> <li>Historical Records</li> </ul>	
<ul style="list-style-type: none"> <li>Ground Water Level</li> </ul>	<ul style="list-style-type: none"> <li>Influences potential water pressure on footings, foundations, and floors</li> <li>Affects site design techniques for controlling water runoff</li> </ul>	<ul style="list-style-type: none"> <li>Geologic Surveys</li> <li>Soil Analysis Reports</li> </ul>	
<ul style="list-style-type: none"> <li>Structural Flood Control Measures (e.g., dams, levees, channel improvements)</li> </ul>	<ul style="list-style-type: none"> <li>Existing measures can affect site if the limits of the flood control device are exceeded</li> <li>Proposed measures can, when implemented, alter basic flood data</li> </ul>	<ul style="list-style-type: none"> <li>Feasibility Studies</li> <li>Design Specifications</li> <li>Probability Reports</li> </ul>	

Hydrologic Data

Information Required	Purpose or Implications of Data	Possible Forms of Data	Potential Sources of Information
<ul style="list-style-type: none"> <li>Physiographic Features</li> </ul>	<ul style="list-style-type: none"> <li>Affects location and magnitude of flooding on the site</li> <li>Identifies areas of the site that should be avoided or protected</li> <li>Affects orientation, distribution, and density of built elements on the site</li> <li>Identifies physical constraints and advantages for site development</li> </ul>	<ul style="list-style-type: none"> <li>Topographic Maps</li> <li>Floodplain Technical Studies</li> <li>Site Surveys</li> </ul>	<ul style="list-style-type: none"> <li>Local Government Planning Agency</li> <li>Local Government Municipal Engineer</li> <li>State Floodplain Coordinating Agency</li> <li>State Office for Natural Resources</li> </ul>
<ul style="list-style-type: none"> <li>Topography</li> </ul>	<ul style="list-style-type: none"> <li>Influences siting of buildings</li> <li>Indicates erosion potential</li> <li>Indicates need for, and feasibility of using, fill material on the site</li> <li>Indicates appropriate site design techniques for controlling water runoff</li> </ul>	<ul style="list-style-type: none"> <li>Topographic Maps</li> <li>Floodplain Technical Studies</li> <li>Site Surveys</li> </ul>	<ul style="list-style-type: none"> <li>Soil Conservation Service U.S. Department of Agriculture</li> <li>U.S. Geologic Survey</li> <li>Regional Authorities</li> </ul>
<ul style="list-style-type: none"> <li>Soil Characteristics</li> </ul>	<ul style="list-style-type: none"> <li>Soil porosity influences the rate of water runoff and flooding potential</li> <li>Determines the feasibility and design specifications for use of fill material to elevate buildings, the use of backfill around foundations, and construction of earth berms</li> <li>Indicates required depth for footings, pilings, or columns</li> </ul>	<ul style="list-style-type: none"> <li>Soil Maps</li> <li>Soil Analysis Reports</li> <li>Site Surveys</li> </ul>	<ul style="list-style-type: none"> <li>Hydrologic and Civil Engineering Consultants</li> <li>Surveys by Professional Staff</li> <li>U.S. Department of the Interior Water and Power Resources Service (operates west of the Mississippi River)</li> </ul>
<ul style="list-style-type: none"> <li>Slope Stability</li> </ul>	<ul style="list-style-type: none"> <li>Affects choice of building sites, the use of fill material, and the design of foundations, footings and pilings</li> <li>Influences erosion</li> <li>Indicates the need for terracing or ground cover to protect slopes</li> </ul>	<ul style="list-style-type: none"> <li>Analysis of combined effects of topography and soil characteristics</li> <li>Site Surveys</li> </ul>	
<ul style="list-style-type: none"> <li>Vegetation</li> </ul>	<ul style="list-style-type: none"> <li>Aids in control of water runoff, and thus can be a factor in reducing flooding levels</li> </ul>	<ul style="list-style-type: none"> <li>Site Surveys</li> </ul>	
<ul style="list-style-type: none"> <li>Water Storage</li> </ul>	<ul style="list-style-type: none"> <li>Aids in control of water runoff, and thus can be a factor in reducing flooding levels</li> <li>Recharges ground water supplies</li> </ul>	<ul style="list-style-type: none"> <li>Geologic, soil, and hydrologic surveys</li> <li>Site Surveys</li> </ul>	

Site Characteristics

# FEMA Regional Offices

---

The Federal Emergency Management Agency (FEMA) was created in 1978 to provide a single point of accountability for all federal activities related to disaster mitigation and emergency preparedness and response. It was established as an independent agency in the executive branch to consolidate a variety of existing agencies and offices performing related functions. The Federal Insurance Administration (FIA), formerly a part of the Department of Housing and Urban Development, is only responsible for administering the National Flood Insurance Program. This responsibility includes assisting state and local governments in the implementation of flood-plain management programs and providing information on flooding to communities and individuals. Regional offices are the primary means by which FEMA's programs are carried out at the state and local level.



## Region I

Connecticut, Maine,  
Massachusetts, New Hampshire,  
Rhode Island &  
Vermont

J.W. MacCormack Post  
Office Building, Room 442  
Boston, Massachusetts 02109  
(617) 223-9540

## Region II

New Jersey, New York,  
Puerto Rico & Virgin Islands

26 Federal Plaza  
Rm. 1349  
New York, New York 10278  
(212) 264-8980

## Region III

Delaware, District of  
Columbia, Maryland,  
Pennsylvania, Virginia &  
West Virginia

Liberty Square Building  
105 South Seventh Street  
Philadelphia, Pennsylvania  
19106  
(215) 597-9416

## Region IV

Alabama, Florida, Georgia,  
Kentucky, Mississippi,  
North Carolina, South  
Carolina & Tennessee

1375 Peachtree Street, N.W.  
Suite 700  
Atlanta, Georgia 31792  
(404) 347-2400

<b>Region V</b>	Illinois, Indiana, Michigan, Minnesota, Ohio & Wisconsin  300 South Wacker Drive 24th Floor Chicago, Illinois 60606 (312) 353-8661	<b>Region VIII</b>	Colorado, Montana, North Dakota, South Dakota, Utah & Wyoming  Federal Regional Center Building 710, Box 25267 Denver, Colorado 80225 (303) 235-4811
<b>Region VI</b>	Arkansas, Louisiana, New Mexico, Oklahoma & Texas  Federal Regional Center Rm. 206 800 North Loop 288 Denton, Texas 76201 (817) 387-5811	<b>Region IX</b>	Arizona, California, Hawaii & Nevada  Building 105 Presidio of San Francisco San Francisco, California 94129 (415) 556-8794
<b>Region VII</b>	Iowa, Kansas, Missouri & Nebraska  911 Walnut Street Room 300 Kansas City, Missouri 64106 (816) 374-5912	<b>Region X</b>	Alaska, Idaho, Oregon & Washington  Federal Regional Center 130 228th Street, S.W. Bothell, Washington 98011 (206) 481-8800



Federal Emergency Management Agency  
Regional Offices and Boundaries

# State Coordinating Offices for the NFIP

---

Each of the states, in cooperation with the Federal Emergency Management Agency, has designated a specific agency to coordinate implementation of the National Flood Insurance Program. This agency provides a link between federal, state, and local levels of government and between different state agencies with flood-related responsibilities. The designated agency will typically be a department responsible for natural resources, emergency services, or physical development, and is a focal point for information relating to flood insurance and floodplain management. It can be an important source of physical data, information on community eligibility for flood insurance, relevant state regulations, references to other agencies, and, in some instances, technical assistance. The authority of each state's coordinating agency varies, and can best be determined through direct contact.

**Alabama** Department of Economics  
and Community Affairs  
State Planning Division  
P.O. Box 2939  
3465 Norman Bridge Road  
Montgomery, Alabama 36105  
(205) 284-8735

**Alaska** Department of Community  
& Regional Affairs  
Division of Municipal  
and Regional Affairs  
949 East 36 Avenue  
Suite 400  
Anchorage, Alaska 99508  
(907) 561-8586

**Arizona** Department of Water  
Resources  
Flood Control Branch  
99 E. Virginia 2nd Floor  
Phoenix, Arizona 85004  
(602) 255-1566

**Arkansas** Soil & Water  
Conservation Commission  
#1 Capitol Mall  
Suite 2D  
Little Rock, Arkansas 72201  
(501) 371-1611

**California** Department of Water  
Resources  
P.O. Box 388  
Sacramento, California 95802  
(916) 445-6249

**Colorado** Colorado Water  
Conservation Board  
State Centennial Building,  
Room 823  
1313 Sherman Street  
Denver, Colorado 80202  
(303) 866-3441

**Connecticut** Dept. of Environmental  
Protection  
165 Capitol Avenue  
Hartford, Connecticut 06106  
(203) 566-7245

**Delaware** Dept. of Natural &  
Environmental Control  
Division of Soil & Water  
Conservation  
Edward Tatnall Building  
P.O. Box 1401  
Dover, Delaware 19901  
(302) 736-4411

**District of  
Columbia** Department of Consumer  
Regulatory Affairs  
614 H Street, N.W.  
Washington, D.C. 20001  
(202) 727-7577

<b>Florida</b>	Department of Community Affairs Div. of Resource Planning and Management 2571 Executive Ctr. Circle East Tallahassee, Florida 32301 (904) 488-9210	<b>Iowa</b>	Iowa Natural Resources Council Wallace State Office Building Des Moines, Iowa 50319 (515) 281-5029
<b>Georgia</b>	Georgia Department of Natural Resources, Environmental Protection Division 19 Martin Luther King, Jr. Dr., S.W., Room 400 Atlanta, Georgia 30334 (404) 656-3214	<b>Kansas</b>	Kansas State Board of Agriculture Division of Water Resources 109 Southwest Ninth Street Topeka, Kansas 66612 (913) 296-3717
<b>Guam</b>	Office of Civil Defense Post Office Box 2877 Agana, Guam 96910 011-671-477-9841	<b>Kentucky</b>	Department of Natural Resources Division of Water 18 Reilly Road Fort Boone Plaza Frankfort, Kentucky 40601 (502) 564-3410
<b>Hawaii</b>	Hawaii Board of Land and Natural Resources P.O. Box 373 Honolulu, Hawaii 96809 (808) 548-7539	<b>Louisiana</b>	Louisiana Department of Urban & Community Affairs P.O. Box 44455, Capitol Station Baton Rouge, Louisiana 70804 (504) 925-3730
<b>Idaho</b>	Department of Water Resources State House Boise, Idaho 83720 (208) 334-4470	<b>Maine</b>	Bureau of Civil Emergency Preparedness State House 187 State Street Augusta, Maine 04330 (207) 289-3154
<b>Illinois</b>	Illinois Department of Transportation Division of Water Resources Local Flood Plain Programs 300 North State Street, Room 1010 Chicago, Illinois 60610 (312) 793-3864	<b>Maryland</b>	Maryland Water Resources Administration Flood Management Section Tawes State Office Building D-2 Annapolis, Maryland 21401 (301) 269-3826
<b>Indiana</b>	Department of Natural Resources 608 State Office Building Indianapolis, Indiana 46204 (317) 232-4160	<b>Massachusetts</b>	Massachusetts Water Resources Commission State Office Building 100 Cambridge Street Boston, Massachusetts 02202 (617) 727-3267



---

**Michigan** Michigan Department of  
Natural Resources  
Water Management Division  
P.O. Box 30028  
Lansing, Michigan 48909  
(517) 373-3930

**Minnesota** Minnesota Department of  
Natural Resources  
Division of Waters  
444 LaFayette Road  
St. Paul Minnesota 55101  
(612) 296-9226

**Mississippi** Mississippi Research &  
Development Center  
3825 Ridgewood Road  
Jackson, Mississippi 39211  
(601) 982-6376

**Missouri** Department of Natural  
Resources  
1101 R. Southwest Blvd.  
P.O. Box 1368  
Jefferson City, Missouri  
65102  
(314) 751-4932

**Montana** Department of Natural  
Resources & Conservation  
32 South Ewing Street  
Helena, Montana 59601  
(406) 449-6646

**Nebraska** Nebraska Natural Resources  
Commission  
P.O. Box 94876  
Lincoln, Nebraska 68509  
(402) 471-2081

**Nevada** Division of Emergency  
Management  
Capitol Complex  
Carson City, Nevada 89710  
(702) 885-4240

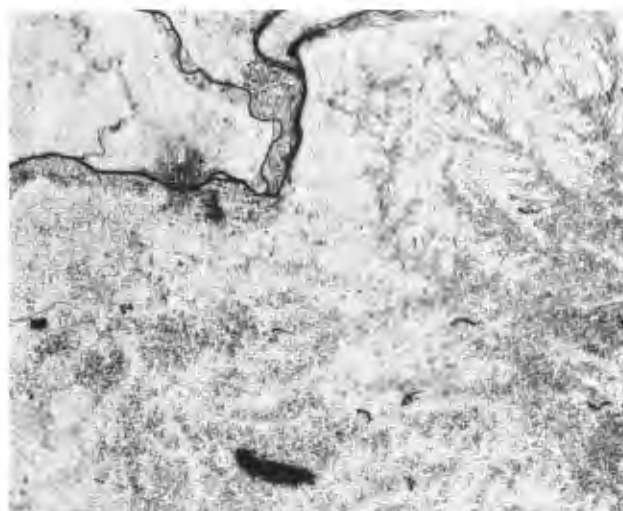

**New Hampshire** New Hampshire Office of  
State Planning  
2½ Beacon Street  
Concord, NH 03301  
(603) 271-2231

**New Jersey** New Jersey Department of  
Environmental Protection  
Division of Water Resources  
P.O. Box CN 029  
Trenton, New Jersey 08625  
(609) 292-2296

**New Mexico** State Engineer  
Bataan Memorial Bldg.  
Santa Fe, New Mexico  
97501  
(505) 827-6140

**New York** New York Department of  
Environmental  
Conservation  
Flood Protection Bureau  
50 Wolf Road-Room 422  
Albany, New York 12233  
(518) 457-3157

**North Carolina** North Carolina Department  
of Natural Resources &  
Community Development  
Division of Community  
Assistance  
512 North Salisbury Street  
P.O. Box 27687  
Raleigh, North Carolina  
27611  
(919) 733-2850

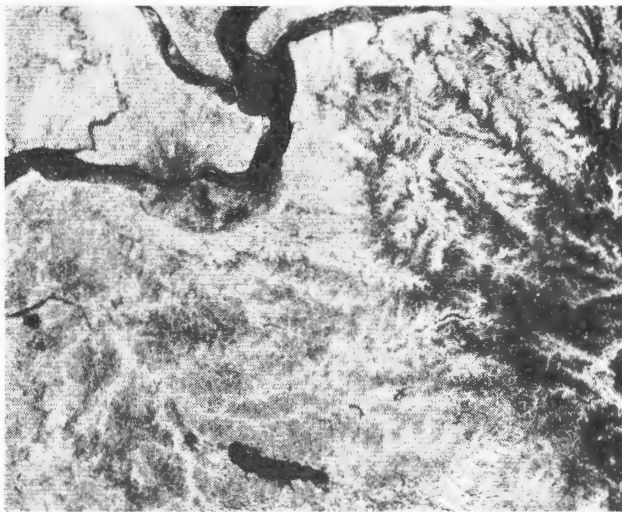

<b>North Dakota</b>	State Water Commission 900 E. Boulevard Bismarck, North Dakota 58501 (701) 224-2750	<b>Puerto Rico</b>	Puerto Rico Planning Board P.O. Box 4119, Minillas Station D-Diego Avenue Santurce, Puerto Rico 00940 (809) 726-7110
<b>Ohio</b>	Ohio Department of Natural Resources Flood Plain Planning Unit Fountain Square Columbus, Ohio 43224 (614) 265-6755	<b>Rhode Island</b>	Rhode Island Office of State Planning Statewide Planning Program 265 Melrose Street Providence, RI 02907 (401) 277-2656
<b>Oklahoma</b>	Oklahoma Water Resources Board 12th Floor Northeast 10th & Stonewall Oklahoma City, OK 73105 (405) 271-2533	<b>South Carolina</b>	South Carolina Water Resources Commission 3830 Forest Drive P.O. Box 4440 Columbia, SC 29240 (803) 758-2514
<b>Oregon</b>	Department of Land Conservation and Development 1175 Court Street, N.E. Salem, Oregon 97310 (503) 378-2332	<b>South Dakota</b>	Department of Military and Veterans Affairs Division of Emergency and Disaster State Capitol Pierre, South Dakota 57501 (605) 773-3231
<b>Pennsylvania</b>	Department of Community Affairs 551 Forum Building, Room 317 Harrisburg, PA 17120 (717) 787-7400	<b>Tennessee</b>	Department of Economic and Community Development Division of Local Planning 1800 James K. Polk Office Building 505 Deaderick Street Nashville, Tennessee 37219 (615) 741-2211
		<b>Texas</b>	Texas Dept. of Water Resources P.O. Box 13087, Capitol Station 1700 North Congress Avenue Austin, Texas 78711 (512) 475-2171
		<b>Utah</b>	Office of Comprehensive Emergency Management 1543 Sunnyside Avenue Salt Lake City, Utah 84108 (801) 533-5271

---

**Vermont**

Environmental Conservation  
Agency  
Division of Water Resources  
State Office Building  
Montpelier, Vermont 05602  
(802) 828-2761

**West Virginia**

West Virginia Office of  
Emergency Services  
Room EB-80  
Capitol Building  
Charleston, WV 25305  
(304) 348-3831

**Virgin Islands**

Disaster Preparedness  
Office  
Box 1208  
St. Thomas, VI 00801  
(809) 774-6555

**Wisconsin**

Department of Natural  
Resources  
Flood Plain-Shoreline  
Management Section  
P.O. Box 7921  
Madison, Wisconsin 53707  
(608) 266-1926

**Virginia**

Virginia State Water  
Control Board  
P.O. Box 11143  
Richmond, Virginia 23230  
(804) 257-0075

**Wyoming**

Wyoming Disaster and Civil  
Defense Agency  
P.O. Box 1709  
Cheyenne, Wyoming 82003  
(307) 777-7566

**Washington**

Department of Ecology  
Mail Stop PV11  
Olympia, Washington  
98504  
(206) 459-6288

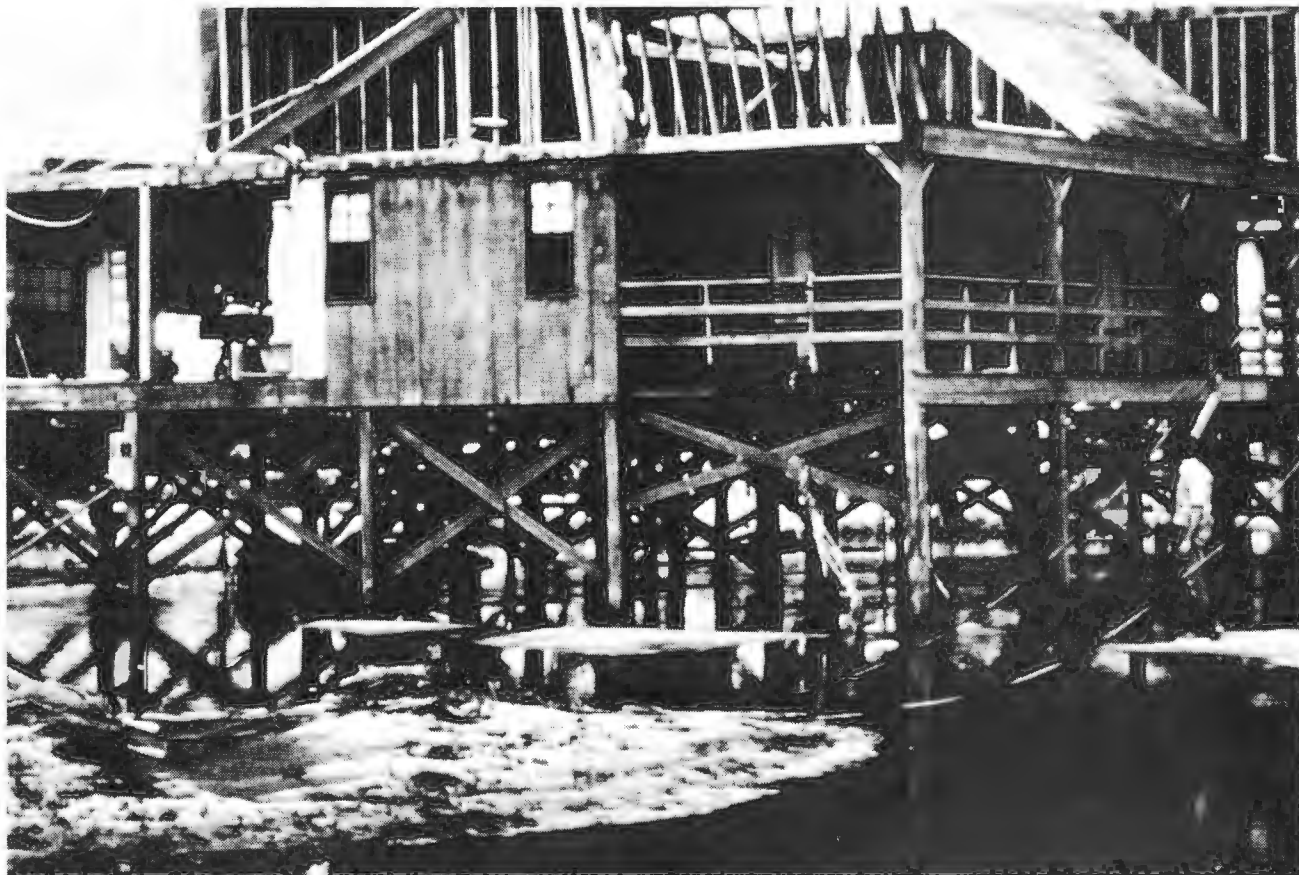

# Performance Criteria

---

The following performance requirements and criteria identify a range of considerations that should be addressed during the design of residential structures for flood hazard areas. These performance criteria do not represent the entire range of items applicable to each requirement. Instead, a selective number of criteria have been presented.

The performance requirements and criteria are applicable to all structural materials and all construction methods used in flood hazard areas. Traditional or conventional construction solutions, as well as innovative techniques, are acceptable so long as the performance requirements and criteria are satisfied.

## DEFINITIONS

Terms important to proper interpretation of the performance requirements and criteria are defined as follows:

### Applicable Codes

The system of legal regulations adopted by a community setting forth standards for the construction, addition, modification, and repair of buildings and other structures for the purpose of protecting the health, safety and general welfare of the public.

### Community

Any state or political subdivision thereof with authority to adopt and enforce floodplain management regulations for areas within its jurisdiction.

### Design Flood (Base Flood)

The design flood is the base or 100-year flood used for purposes of compliance with the National Flood Insurance Program (NFIP).

In coastal high hazard zones the 100-year flood includes wave height above the stillwater level.

## Design Loads

The design load is the minimum loading condition that the building should be designed to resist. Some loading conditions most likely will be defined in the applicable codes while other load conditions (e.g., flood impact loads) will have to be determined. The following loads constitute the design load and should be considered as minimum loading conditions as defined in Criterion A.1 (see below):

### *Dead Load (D)*

The weight of all permanent construction. The dead load includes a) the weight of the structure itself, b) the weight of all materials of construction incorporated into the building that are to be permanently supported by the structure, including built-in partitions, c) the weight of permanent equipment, and d) forces due to prestressing.

### *Gravity Live Load (L)*

Gravity live loads result from both the occupancy (floor) and the environment (roof) of the building, as stipulated in the applicable code. These include, where applicable, loads caused by soil and hydrostatic pressures.

### *Wind Loads (W)*

Wind loads stipulated in the applicable code.

### *Restraint Loads (R)*

Loads, forces, and effects due to contraction or expansion resulting from temperature changes, shrinkage, moisture changes, creep in component materials, movement due to differential settlement or combinations thereof.

---

## Flood Loads (F)

Loads caused by the design flood, which include:

- Flood-induced dimensional changes such as swelling of wood or heave of expansive foundation soils
- Water loads as defined in Section 602.0 of the Corps of Engineers' publication, *Flood-Proofing Regulations*
- Soil loads as defined in Section 604.0 of the Corps of Engineers' publication, *Flood-Proofing Regulations*

Sections of 602.0 and 604.0 of *Flood-Proofing Regulations* (EP 116S-2-314, Office of the Chief of Engineers, U.S. Army, June 1972), are reproduced below:

### SECTION 602.0 WATER LOADS

#### Sec. 602.1 Types

Water loads, as defined herein, are loads or pressures on surfaces of the buildings and structures caused and induced by the presence of flood waters. These loads are of two basic types: hydrostatic and hydrodynamic.

#### Sec. 602.2 Hydrostatic Loads

Hydrostatic loads are those caused by water either above or below the ground surface, free or confined, which is either stagnant or moves at very low velocities, or up to five (5) feet per second. These loads are equal to the product of the water pressure times the surface area on which the pressure acts. The pressure at any point is equal to the product of the unit weight of water (62.5 pounds per cubic foot) multiplied by the height of water above the point or by the height to which confined water would rise if free to do so. Hydrostatic pressures at any point are equal in all directions and always act perpendicular to the surface on which they are applied. For the purpose of these Regulations, hydrostatic loads are subdivided into the following types:

##### Sec. 602.2.1 Vertical Loads

These are loads acting vertically downward on horizontal or inclined surfaces of buildings or structures, such as roofs, decks or floors, and walls, caused by the weight of flood waters above them.

##### Sec. 602.2.2 Lateral Loads

Lateral hydrostatic loads are those which act in a horizontal direction, against vertical or inclined surfaces, both above and below the ground surface and tend to cause lateral displacement and overturning of the building, structure, or parts thereof.

##### Sec. 602.2.3 Uplift

Uplift loads are those which act in a vertically upward direction on the underside of horizontal or sloping surfaces of buildings or structures, such as basement slabs, footings, floors, decks, roofs and overhangs. Hydrostatic loads acting on inclined, rounded or irregular surfaces may be resolved into vertical or uplift loads and lateral loads based on the geometry of the surfaces and the distribution of hydrostatic pressures.

### Sec. 602.3 Hydrodynamic Loads

Hydrodynamic loads . . . are those induced on buildings or structures by the flow of flood water moving at moderate or high velocity around the buildings or structures or parts thereof, above ground level. Such loads may occur below the ground level when openings or conduits exist which allow free flow of flood waters. Hydrodynamic loads are basically of the lateral type and relate to direct impact loads by the moving mass of water, and to drag forces as the water flows around the obstruction. Where application of hydrodynamic loads is required, the loads shall be computed or estimated by recognized and authoritative methods. Methods for evaluating water velocities and related dynamic effects are beyond the scope of these Regulations, but shall be subject to review and approval by the Building Official.

#### Sec. 602.3.1 Conversion to Equivalent Hydrostatic Loads

For cases when water velocities do not exceed 10 feet per second, dynamic effects of the moving water may be converted into equivalent hydrostatic loads by increasing the depth of water to the RFD [use the level of the base or design flood], by an amount  $dh$ , on the headwater side and above the ground level only, equal to:

$$dh = \frac{aV^2}{2g}, \text{ where}$$

$V$  is the average velocity of the water in feet per second;  
 $g$  is the acceleration of gravity, 32.2 feet per second;  
 $a$  is the coefficient of drag or shape factor (The value of  $a$ , unless otherwise evaluated, shall not be less than 1.25)

---

The equivalent surcharge depth,  $dh$ , shall be added to the depth measured between the design level and the RFD and the resultant pressures applied to, and uniformly distributed across, the vertical projected area of the building or structure which is perpendicular to the flow. Surfaces parallel to the flow or surfaces wetted by the tail-water shall be considered subject to hydrostatic pressures for depths to the RFD only.

#### Sec. 602.4 Intensity of Loads

##### Sec 602.4.1 Vertical Loads

Full intensity of hydrostatic pressure caused by a depth of water between the design elevation(s) and the RFD applied over all surfaces involved, both above and below ground.

##### Sec. 602.4.2 Lateral Loads

Full intensity of hydrostatic pressure caused by a depth of water between the design elevation(s) and the RFD applied over all surfaces involved, both above and below ground level, except that for surfaces exposed to free water, the design depth shall be increased by one foot.

##### Sec. 602.4.3 Uplift

Full intensity of hydrostatic pressures caused by a depth of water between the design level and the RFD acting on all surfaces involved . . .

##### Sec. 602.4.4 Hydrodynamic Loads

Hydrodynamic loads, regardless of method of evaluation, shall be applied at full intensity over all above ground surfaces between the ground level and the RFD.

#### Sec. 602.5 Applicability

Hydrostatic loads shall be used in the design of buildings and structures exposed to water loads from stagnant flood waters, for conditions when water velocities do not exceed five (5) feet per second, and for buildings and structures or parts thereof not exposed or subject to flowing water. For buildings and structures, or parts thereof, which are exposed and subject to flowing water having velocities greater than five (5) feet per second, hydrostatic and hydrodynamic loads shall apply.



---

## SECTION 604.0 SOIL LOADS

### Sec. 604.1 Applicability

Full consideration shall be given in the design of buildings, structures and parts thereof, to the loads or pressures resulting from the presence of soils against or over the structure. Loads or pressures shall be computed in accordance with accepted engineering practice, giving full consideration to the effects that the presence of flood water, above or within the soil, has on loads and pressures. When expansive soils are present, the Building Official may require that special provisions be made in foundation and wall design and construction to safeguard against damage due to this expansiveness. He may require a special investigation and report to provide these design and construction criteria.

#### *Flood Impact Loads (FI)*

The loads caused by the design flood as defined in Section 603.0, "Impact Loads," and Section 605.0, "Hurricane and Tidal Wave Loads," of the Corps of Engineers' publication, *Flood-Proofing Regulations*. In the case of Section 605.0, where no specific guidance is provided, design loads shall be recommended by a professional engineer. (Also refer to FIA-7, *Design and Construction Manual for Residential Buildings in Coastal High Hazard Areas*, cited in this manual's preface.)

Section 603.0 of *Flood-Proofing Regulations* is reproduced below:

## SECTION 603.0 IMPACT LOADS

### Sec. 603.1 Types

Impact loads are those which result from floating debris, ice and any floatable object or mass carried by flood waters striking against buildings and structures or parts thereof. These loads are of three basic types: normal, special and extreme.

#### Sec. 603.1.1 Normal Impact Loads

Normal impact loads are those which relate to isolated occurrences of logs, ice blocks or floatable objects of normally encountered sizes striking buildings or parts thereof.

#### Sec. 603.1.2 Special Impact Loads

Special impact loads are those which relate to large conglomerates of floatable objects, such as broken up ice floats and accumulation of floating debris, either striking or resting against a building, structure, or parts thereof.

#### Sec. 603.1.3 Extreme Impact Loads

Extreme impact loads are those which relate to large floatable objects and masses such as runaway barges or collapsed buildings and structures, striking the building, structure or component under consideration.

### Sec. 603.2 Applicability

Impact loads should be considered in the design of buildings, structures and parts thereof as stipulated below:

#### Sec. 603.2.1 Normal Impact Loads

A concentrated load acting horizontally at the RFD or at any point below it, equal to the impact force, produced by a 1,000-pound mass traveling at the velocity of the flood water and acting on a one (1) square foot surface of the structure.

#### Sec. 603.2.2 Special Impact Loads

Where special impact loads are likely to occur, such loads shall be considered in the design of buildings, structures, or parts thereof. Unless a rational and detailed analysis is made and submitted for approval by the Building Official, the intensity of load shall be taken as 100 pounds per foot acting horizontally over a one-foot wide horizontal strip at the RFD [use the level of the base or design flood], or at any level below it. Where natural or artificial barriers exist which would effectively prevent these special impact loads from occurring, the loads may be ignored in the design.

#### Sec. 603.2.3 Extreme Impact Loads

It is considered impractical to design buildings having adequate strength for resisting extreme impact loads. Accordingly, except for special cases when exposure to these loads is highly probable and the resulting damages are extremely severe, no allowances for these loads need be made in the design.

### Flood or Flooding

- A general and temporary condition of partial or complete inundation of normally dry land areas from:

- the overflow of inland or tidal waters
- the unusual and rapid accumulation or runoff of surface waters from any source
- mudslides (i.e., mudflows) which are proximately caused or precipitated by accumulations of water on or under the ground.

- The collapse or subsidence of land along the shore of a lake or other body of water as a result of erosion or undermining caused by waves or currents of water exceeding anticipated cyclical levels or suddenly caused by an unusually high water level in a natural body of water, accompanied by a severe storm, or by an unanticipated force of nature, such as a flash flood or an abnormal tidal surge, or by some similarly unusual and unforeseeable event which results in flooding as defined above.

## PERFORMANCE REQUIREMENTS AND CRITERIA FOR RESIDENTIAL STRUCTURES IN FLOOD HAZARD AREAS

### PERFORMANCE REQUIREMENT A

The building, its contiguous structure(s), and its service systems shall be designed to withstand the design flood without causing unacceptable risks to its occupants or to adjacent property owners.

The building complies with Performance Requirement A if the following conditions are satisfied:

#### Criterion A.1: Strength

The building is designed to resist the following loads, acting simultaneously:

- 1.1 D, L, R, and F
- 1.2 D, L, R, F, and Fl
- 1.3 D, L, R, W, F, and Fl
- 1.4 D, R, and F

- 1.5 D, R, W, F, and Fl

Where the working stress method of design is used the following provisions apply:

- 2.1 In load combinations 1.1 through 1.5 all loads are applied as listed or as required by the applicable codes for the same load combinations with loads F and Fl.
- 2.2 Allowable (working) stresses cannot be exceeded for loading conditions 1.1 and 1.4. For all other loading conditions the allowable stresses can be increased by the amount permitted in applicable codes for design against load combinations including wind or earthquake load.

Where ultimate-load design is used (such as instances where the American Concrete Institute, *Building Code Requirements for Reinforced Concrete* [ACI 378, ACI, Detroit, current edition], is applicable) load factors are applied as recommended in the applicable standard, and F will be combined with L, or factored as if it were a live load for loading conditions 1.1 and 1.4. For all other loading conditions loads F + Fl will be combined with W, or considered to be equivalent to a wind load.

#### Test

Structural analysis and/or physical simulation.

#### Commentary

The criterion provides a suitable margin of safety against structural collapse when the building is subjected to the base flood. The intent of the criterion is that the margin of safety for these buildings, when subjected to the base flood, be no less than the margin required for other buildings not subjected to flooding. It is assumed that loads F may act on the building over a long period of time, while loads Fl are short-term loads. Thus the margin of safety against load combinations containing Fl need not exceed that provided against wind or seismic loads.



---

The combined load of earthquakes and floods is not considered here because of the low probability of a flood and an earthquake occurring simultaneously. Where tsunami flooding is the base flood, earthquake loading should perhaps be considered concurrently.

### Criterion A.2: Stability and Flotation

There shall be a factor of safety of 1.5 against overturning, sliding, and flotation under the following load:

$$D + W + R + F + Fl$$

#### Test

Structural analysis and/or physical simulation.

#### Commentary

This criterion provides a suitable margin of safety against sliding and overturning. The most critical load combination is being considered. Tie-down devices can be used to achieve structural stability, provided it can be demonstrated that deterioration of these devices during the service life of the building or by flood conditions will not cause the factor of safety to fall below its stipulated value.

### Criterion A.3: Provision Against Debris and Scour

Unless it can be demonstrated that the flood waters will be stagnant, or that there will be no floating debris during the design flood, the following provisions apply:

- 1.1 Building on stilts shall comply with Section 612.2.3 of the Corps of Engineers' publication, *Flood-Proofing Regulations*. This section is reproduced below.

#### Sec. 612.2.3 Building on "Stilts"

The building may be constructed above the RFD [use the level of the base or design flood] by supporting it on "stilts" or other columnar type members, such as columns, piers, and in certain cases, walls. Clear spacing of support members, measured perpendicular to the general

direction of flood flow shall not be less than eight (8) feet apart at the closest point. The "stilts" shall, as far as practicable, be compact and free from unnecessary appendages which would tend to trap or restrict free passage of debris during a flood. Solid walls, or walled in columns are permissible if oriented with the longest dimension of the member parallel to the flow. "Stilts" shall be of a type that causes the least obstruction to the flow and the least potential for trapping floating debris. Foundation supports for the "stilts" may be of any approved type capable of resisting all applied loads, such as spread footings, mats, piles and similar types. In all cases, the effect of submergence of the soil and additional flood water related loads shall be recognized. The potential of surface scour around the stilts shall be recognized and protective measures provided, as required.

- 1.2 For flow velocities in excess of 5 feet per second the hydrodynamic loads in F shall be assumed to act over the entire width of the building, perpendicular to the direction of flow, and reasonable vertical clearance shall be provided for the passage of debris. The depth of all foundation elements shall allow for the potential effect of scour.

#### Test

Structural analysis and/or physical simulation. Evaluation of data and documentation for design, tests, and installation; evaluation of plans and specifications.

#### Commentary

Criterion A.3 is designed to prevent structural collapse caused by the accumulation of floating debris or the undermining of foundation elements as a result of scour. Part of the provision is designed to avoid debris accumulation. The other part provides adequate strength to resist the effects of the formation of a barrier over the entire width of the building. Buildings are exempt if it can be demonstrated that no debris will accumulate and no scour will occur.

---

#### Criterion A.4: Disruption of Service Systems

The service systems shall be designed to resist the loads stipulated in Criterion A.1 with safety margins as stipulated in A.1 against disruptions which may endanger human lives.

##### Test

Engineering analysis and/or physical simulation. Evaluation of data and documentation for design, tests, and installation; evaluation of plans and specifications.

##### Commentary

This criterion only applies to disruption which may cause fatal accidents, such as rupture of gas lines. Lesser load levels are stipulated in B.1 for disruptions which constitute a health hazard.

#### Criterion A.5: Execution of Rescue Operations

The building is designed to permit the execution of rescue operations.

During the duration and at heights of the design flood the building shall:

- 1.1 Allow the safe evacuation of the occupants out of the building
- 1.2 Allow the safe transfer of occupants from the building to rescue vehicles
- 1.3 Provide means of access or adjacency for rescue vehicles.

##### Test

Evaluation of data and documentation for design, tests, and installation; evaluation of plans and specifications.

##### Commentary

Criterion A.5 is designed to prevent the entrapment of building occupants by rising water levels. Part of the provision is designed to provide means to evacuate the building (e.g., windows, roof trap door). The other parts provide for the accommodation and execution of rescue operations (e.g., by boat, helicopter).



---

## PERFORMANCE REQUIREMENT B

The building, its contiguous structure(s), and its service systems shall be designed to withstand the design flood without causing unacceptable health hazards to its occupants.

The building complies with Performance Requirement B if the following conditions are satisfied:

### Criterion B.1: Disruption of Utility Connections

Building utility connections shall be designed to resist the following loads:

At loading conditions:

1.1  $D + L + R + W + F + FI$

1.2  $D + W + R + F + FI$

The building utility connections should not sustain:

2.1 Permanently disrupted and/or broken attachment with their fixtures and/or supporting structural elements

2.2 Leakage or escape of effluent that could contaminate drinking water

2.3 Rupture of electrical service that could cause electrocution and/or fire.

### Test

Evaluation of data and documentation for design, tests, and installations; evaluation of plans and specifications. Inspection and/or testing of built elements when deemed essential. Determination of conformance to generally accepted codes, standards and engineering and trade practices, where applicable.

### Commentary

This criterion applies to all utility connections subject to the forces of the design flood. Utility connections which are designed to disconnect

during the design flood without the release of deleterious substances are exempt from provisions 1.1 and 1.2.

### Criterion B.2: Provision Against Drinking Water Contamination

There will be no contamination of drinking water with sewer effluent or flood water.

Criterion B.2 and Performance Requirement B are deemed satisfied if the following provisions are met.

1.1 Approved backflow preventers or devices are installed on main water service lines, at water wells and/or at suitable building locations to protect the system from backflow or back siphonage of flood waters or other contaminants in the event of a line break or temporary disconnection.

Devices are installed at accessible locations and maintained in good working order.

1.2 Sanitary sewer and storm drainage system connections are provided with approved backflow preventers or devices installed at each discharge point.

1.3 No storm or flood waters are drained into systems designed for sewage only, and vice versa.

### Test

Evaluation of data and documentation for design, tests, and installation; evaluation of plans and specifications.

### Commentary

Criterion B.2 is designed to prevent contamination of drinking water with sewer effluent or flood waters. Also, the criterion is designed to prevent damage to fixtures and interior finishes (e.g., flooring, wall surfaces) from backflow or back siphonage of flood waters.

---

**Criterion B.3: Provision Against Contamination of Potable Water Wells**

Private potable water wells shall not be contaminated by toxic substances or impurities caused by the design flood.

Criterion B.3 is deemed satisfied if the following provisions are satisfied.

- 1.1 Private potable well water is not supplied from a water table located less than 25 feet below grade, nor from any deeper supply which may be polluted by contamination entering fissure or crevice formations.
- 1.2 Each well is provided with a watertight casing to a distance of at least 25 feet below the ground surface that extends at least one foot above the well platform.

**Test**

Evaluation of data and documentation for design, tests, and installation; evaluation of plans and specifications.

Geological analysis of site.

**Commentary**

Criterion B.3 is designed to prevent the contamination of water wells used as a source for potable water. Part of the provision provides against the contamination of the water supply source. The other part provides against the contamination of the water removal system. In any case, local health codes should be consulted.

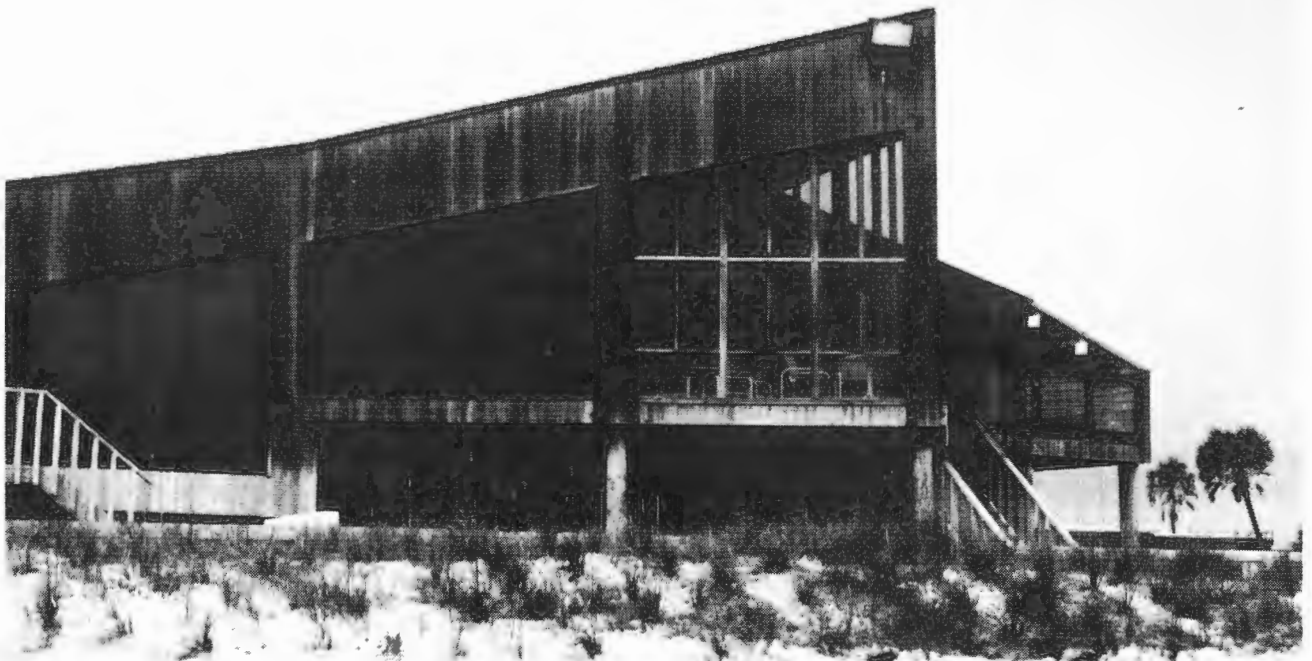

---

## PERFORMANCE REQUIREMENT C

The building, its contiguous structure(s), and its service systems shall be designed to withstand the design flood without sustaining damage of unacceptable magnitude.

The building complies with Performance Requirement C if the following conditions are satisfied:

### Criterion C.1: Provision Against Permanent Damage

Under loading conditions 1.1 through 1.3 the building as a whole, or any element thereof, shall not suffer permanent damage which would require replacement or major repair, or which would extensively impair its intended function.

- 1.1 D + L + R + W + F + FI
- 1.2 D + W + R + F + FI
- 1.3 D + L + R + F + FI

The criterion is deemed satisfied if stress and deflection limits under loading conditions 1.1 through 1.3 do not exceed those stipulated in applicable codes, or if it can be demonstrated that deflections caused by load combinations 1.1 through 1.3 can be accommodated by suitable detail and adequate flexibility of elements.

### Test

Evaluation of data and documentation for design, tests, and installation; evaluation of plans and specifications. Inspection and/or testing of built elements when deemed essential. Determination of conformance to generally accepted standards and engineering and trade practices, where applicable.

### Commentary

This criterion assures that the design flood will not cause excessive damage. Effects of swelling caused by increased moisture or inundation must be included in F.

### Criterion C.2: Provision Against Unnecessary Damage

All living areas, major utilities, furnaces, and air-conditioning units shall not be submerged by the design flood.

- 1.1 Living areas shall be considered habitable areas that provide for the essential needs of people: living, sleeping, dining, cooking and sanitation.

Recreation areas, libraries, and other speciality areas are to be considered habitable areas and therefore should not be submerged by the design flood.

- 1.2 The electrical system complies with Criterion C.2 if the following conditions are satisfied:

- 1.2.1 All portions of the electrical system installed below the design flood level are suitable for continuous submergence in water. Only submersible type splices are used and conduits located below the design flood level are self draining if subject to flooding.

- 1.2.2 Lighting panels, distribution panels, and all other stationary electrical equipment are located above the design flood.

- 1.3 The mechanical system complies with Criterion C.2 if the following conditions are satisfied:

- 1.3.1 Heating, air-conditioning, and ventilating are installed above the design flood.

- 1.3.2 All duct work for warm air heating systems located below the design flood level is provided with emergency openings for drainage of ducts after a flood condition.

- 1.4 The plumbing system complies with Criterion C.2 if the following conditions are satisfied:

- 1.4.1 Tanks, softeners and heaters are installed above the design flood.

---

1.4.2 Plumbing below the design flood level will not suffer loss of stability or loss of tightness that will permit leakage or physical damage to fixtures and joints and connections that will permanently impair functioning.

1.4.3 Utility connections designed to disconnect during the design flood are easily reconnected. (See Criterion B.1.)

#### Commentary

Criterion C.2 is designed to prevent unnecessary damage of living areas, major utilities, furnaces, and air-conditioning units by the design flood. Part of the provision is designed to elevate living areas and equipment above the design flood. Other parts are designed to prevent the damage of utilities and mechanical/electrical connections below the design flood.

#### Test

Evaluation of data and documentation for design, tests, and installation; evaluation of plans and specifications.



## References

---

- AIA Research Corporation. *Design Guidelines for Flood Damage Reduction*. Washington, D.C.: Federal Emergency Management Agency, 1981.
- American Concrete Institute. *Building Code Requirements for Reinforced Concrete* (ACI 318). Detroit: ACI, current edition.
- American Institute of Architects. *Coastal Zone Management: Balancing Protection and Growth*. Washington, D.C.: AIA Component Affairs, 1978.
- American National Standards Institute, Inc. *Specifications and Dimensions for Wood Poles, ANSI 051.1*. New York: ANSI, current edition.
- American Wood Preservers Institute. *AWPI Technical Guidelines for Pressure-treated Wood: Selection of Treated Timber Piling*. McLean, Va.: AWPI, 1971.
- American Wood Preservers Institute. *FHA Pole House Construction*. Washington, D.C.: AWPI, 1971.
- Anderson, L. O and Smith, Walton R. *Houses Can Resist Hurricanes*. Madison, Wis.: U.S. Forest Products Laboratory, 1965.
- Association of State Flood Plain Managers. *Model State Legislation for Floodplain Management*. Madison, Wis.: ASFPM, May 1982.
- Bloomgreen, Patricia A. *Strengthening State Floodplain Management*. National Hazards Research and Applications Information Center Special Publication 3. Boulder, Colo.: Institute of Behavioral Science, University of Colorado, 1982.
- Clay, Grady, ed. *Water and the Landscape*. New York: McGraw-Hill Book Co., 1979.
- Conservation Foundation. *Coastal Environmental Management*. Washington, D.C.: U.S. Government Printing Office, 1980.
- Dunne, Thomas, and Leopold, Luna. *Water in Environmental Planning*. San Francisco: W.H. Freeman and Co., 1978.
- Federal Emergency Management Agency. *Elevating to the Wave Crest Level: A Benefit-Cost Analysis*. Washington, D.C.: FEMA, July 1980.
- Federal Emergency Management Agency. *Flood Emergency and Residential Repair Handbook*. Washington, D.C.: U.S. Government Printing Office, October 1979.
- Federal Emergency Management Agency. *Floodplain Management: Ways of Estimating Wave Heights in Coastal High Hazard Areas in the Atlantic and Gulf Coast Regions*. Washington, D.C.: FEMA, April 1981.
- Federal Emergency Management Agency and U.S. Department of Housing and Urban Development. *Design and Construction Manual for Residential Buildings in Coastal High Hazard Areas*. Washington, D.C.: FEMA, January 1981.
- Flood Loss Reduction Associates. *Cooperative Flood Loss Reduction: A Technical Manual for Communities and Industry*. Washington, D.C.: U.S. Government Printing Office, June 1981.
- Geis, Donald and Steeves, Barry. "Designing Against Flood Damage," *AIA Journal*, November 1980, pp. 52-58.
- General Adjustment Bureau, Inc. *Nature's Destructive Forces*. New York: GAB, 1973.
- Great Lakes Basin Commission. *The Role of Vegetation in Shoreline Management*. Chicago: U.S. Army Corps of Engineers, North Central Division 1977.
- Hunt, Charles B. *Natural Regions of the United States and Canada*. San Francisco: W.H. Freeman and Co., 1974.

---

Johnson, William U. *Physical and Economic Feasibility of Nonstructural Flood Plain Management Measures*. Davis, Calif.: U.S. Army Corps of Engineers Hydrologic Engineering Center, 1978.

Kusler, Jon A., and Lee, Thomas M. *Regulations for Flood Plains*. Chicago: American Society of Planning Officials, 1972.

Leopold, Luna B. *Water: A Primer*. San Francisco: W.H. Freeman and Co., 1974.

National Flood Insurers Association. *National Flood Insurance Program—Flood Insurance Manual*. New York: NFIA, current edition.

National Science Foundation. *A Report on Flood Hazard Mitigation*. Washington, D.C.: NSF, September, 1980.

Owen H. James. *Annotations of Selected Literature on Nonstructural Flood Plain Management Measures*. Davis, Calif.: U.S. Army Corps of Engineers Hydrologic Engineering Center, March 1977.

Pilkey, Orrin H. Jr., Pilkey, O.H. Sr., and Turner, Robb. *How to Live with an Island*. Raleigh, N.C.: Science & Technology Section, North Carolina Department of Natural & Economic Resources, 1975.

Phippen, George R., "A New Course to Ararat," *Water Spectrum*, Summer 1971, pp. 9-15.

Sheaffer, John R. *Introduction to Flood Proofing*. Chicago: Center for Urban Studies, University of Chicago, 1967.

Tennessee Valley Authority. *Guide for the Use of Technical Information and Data for Floodplain Management in the Tennessee River Basin*. Knoxville, Tenn.: TVA, October 1980.

Texas Coastal and Marine Council. *Model Minimum Hurricane-Resistant Building Standards for the Texas Gulf Coast*. Austin: September 1976.

U.S. Army Corps of Engineers. *Flood-Proofing Regulations*. Washington, D.C.: U.S. Army, Office of the Chief of Engineers, 1972.

U.S. Army Corps of Engineers. *Low Cost Shore Protection*. Washington, D.C.: U.S. Army, Office of the Chief of Engineers, 1981.

U.S. President, Executive Order 11296, Floodplain Management, *Code of Federal Regulations*, 1970 ed., Title 3, p. 181, USC 701.

U.S. President. Executive Order 11988, Floodplain Management. *Federal Register*, 42/101, 25 May 1977.

U.S. President, Executive Order 11990, Protection of Wetlands. *Federal Register*, 42/101, 25 May 1977.

U. S. Water Resources Council. *Regulation of Flood Hazard Areas to Reduce Losses*. Washington, D.C.: Water Resources Council, 1971-1972.

U.S. Water Resources Council. *Flood Hazard Evaluation Guidelines for Federal Agencies*. Washington, D.C.: Water Resources Council, 1972.

U.S. Water Resources Council. *Unified National Program for Flood Plain Management*. Washington, D.C.: Water Resources Council, 1976.

Waananan, A.O., et al. *Flood-Prone Areas and Land-Use Planning—Selected Examples from the San Francisco Bay Region, California*. U.S. Geological Survey Professional Paper 942. Washington, D.C.: U.S. Government Printing Office, 1977.